

ROLLER DOOR OPENER

Installation Instruction and User Guide



WARNING:

- Please read the manual carefully before installation and use.
- The installation of your new door opener must be carried out by technically qualified or licensed person.
- Attempting to install or repair the door opener without suitable technical qualification may result in severe personal injury, death and /or property damage.

CONTENTS

IMPORTANT SAFETY RECOMMENDATIONS	1
1.PACKAGE CONTENTS	2
2.TOOLS REQUIRED	3
3.DOOR REQUIREMENTS	4
4.PRE-INSTALLATION RECOMMENDATIONS	5
5.ATTACHING THE WEIGHT BAR	5
6.CURTAIN FIXING(IF REQUIRED).....	6
7.THE RELEASE HANDLE & CORD.....	6
8.OPERATING THE MANUAL RELEASE.....	7
9.LEFT/RIGHT SIDE INSTALLATION	8
10.ATTACHING EXTENSION BAR (IF REQUIRED)	8
11.INSTALLATION PROCEDURE.....	8
12.INSTALLATION CONTROL BOX(IF REQUIRED).....	9
13.CONTROL PANEL INSTALLATION MANUAL	10
14.FUNCTIONAL SPECIFICATIONS	13
15.SAFETY REVERSE TEST	26
16.DESCRPTION OF EXTERNAL PORT	27
17.SPECIFICATION.....	28
18.FAULT ALARM DISPLAY CODE,CAUSE AND SOLUTION	28
19.COMMON FAULTS & SOLUTIONS	29
20.PARTS LIST	31
21.MAINTENANCE.....	33

Installation Instruction and User Guide

IMPORTANT SAFETY RECOMMENDATIONS

WARNING

• **FAILURE TO COMPLY WITH THE FOLLOWING SAFETY RECOMMENDATIONS MAY RESULT IN SERIOUS PERSONAL INJURY, DEATH AND / OR PROPERTY DAMAGE.**

• **PLEASE READ CAREFULLY AND ADHERE TO ALL SAFETY AND INSTALLATION RECOMMENDATIONS.**

1. The opener is designed and manufactured to meet local regulations. The installer must be familiar with local regulations required in respect of the installation of the opener.
2. Unqualified personnel or those persons who do not know the occupational health and safety standards being applicable to automatic gates and other doors, must in no circumstances carry out installations or implement systems.
3. Persons who install or service the equipment without observing all the applicable safety standards will be responsible for any damage, injury, cost, expense or claim whatsoever any person suffered as a result of failure to install the system correctly and in accordance with the relevant safety standards and installation manual whether directly or indirectly.
4. For additional safety we strongly recommend the inclusion of Photo Beam. Although the opener incorporates a pressure sensitive Safety Obstruction Force system the addition of Photo Beam will greatly enhance the operating safety of an automatic garage door and provide additional peace of mind.
5. Make sure that the garage door is fully open & stationary before driving in or out of the garage.
6. Make sure the garage door is fully closed & stationary before leaving.
7. Keep hands and loose clothing off the opener and garage door all the time.
8. The Safety Obstruction System is designed to work on STATIONARY objects only. Serious personal injury, death and / or property damage may occur if the garage door comes into contact with a moving object
9. This appliance is not intended for use by persons (including children) with reduced physical, sensory or mental capabilities, or lack of experience and knowledge, unless they have been given supervision or instruction concerning use of the appliance by a person responsible for their safety. Children should be supervised to ensure that they do not play with the appliance.



10. Waste electrical products should not be disposed of with household waste. Please recycle where facilities exist. Check with your local authority or retailer for recycling advice.
11. If the supply cord is damaged, it must be replaced by the manufacturer, its service agent or similarly qualified persons in order to avoid a hazard.
12. Do not allow children to play with door controls. Keep remote controls away from children.
13. Watch the moving door and keep people away until the door is completely opened or closed.

Installation Instruction and User Guide

14. Take care when operating the manual release since an open door may fall rapidly due to weak or broken springs, or being out of balance.
15. Frequently examine the installation, in particular check cables, springs and mountings for signs of wear, damage or imbalance. Do not use if repair or adjustment is needed since a fault in the installation or an incorrectly balanced door may cause injury.
16. Each month check that the drive reverses when the door contacts a 40mm high object placed on the floor. Adjust if necessary and recheck since an incorrect adjustment may present a hazard, for drives incorporating an entrapment protection system depending on contact with the bottom edge of the door.
17. Disconnect the electric power when cleaning or carrying out other maintenance.

NOTE: If your garage has no service entrance door, we recommend an outside quick release must be installed. This accessory allows manual operation of the garage door from outside in case of power failure,.

1.PACKAGE CONTENTS

1. Instruction manual
2. Clamp bracket,plates,washers (2) and nuts (2)
3. Weight bar
4. Transmitter (2)
5. Weight bar screws(2) and nuts(2)
6. Warning label
7. Wall bracket、 set screws (4)
8. self-tapping screw (2) (Used for fixing door curtain)
9. Wire Clip (3) 、 Connecting wire(Used for connecting control box to motor)
10. Release handle
11. Motor

Installation Instruction and User Guide

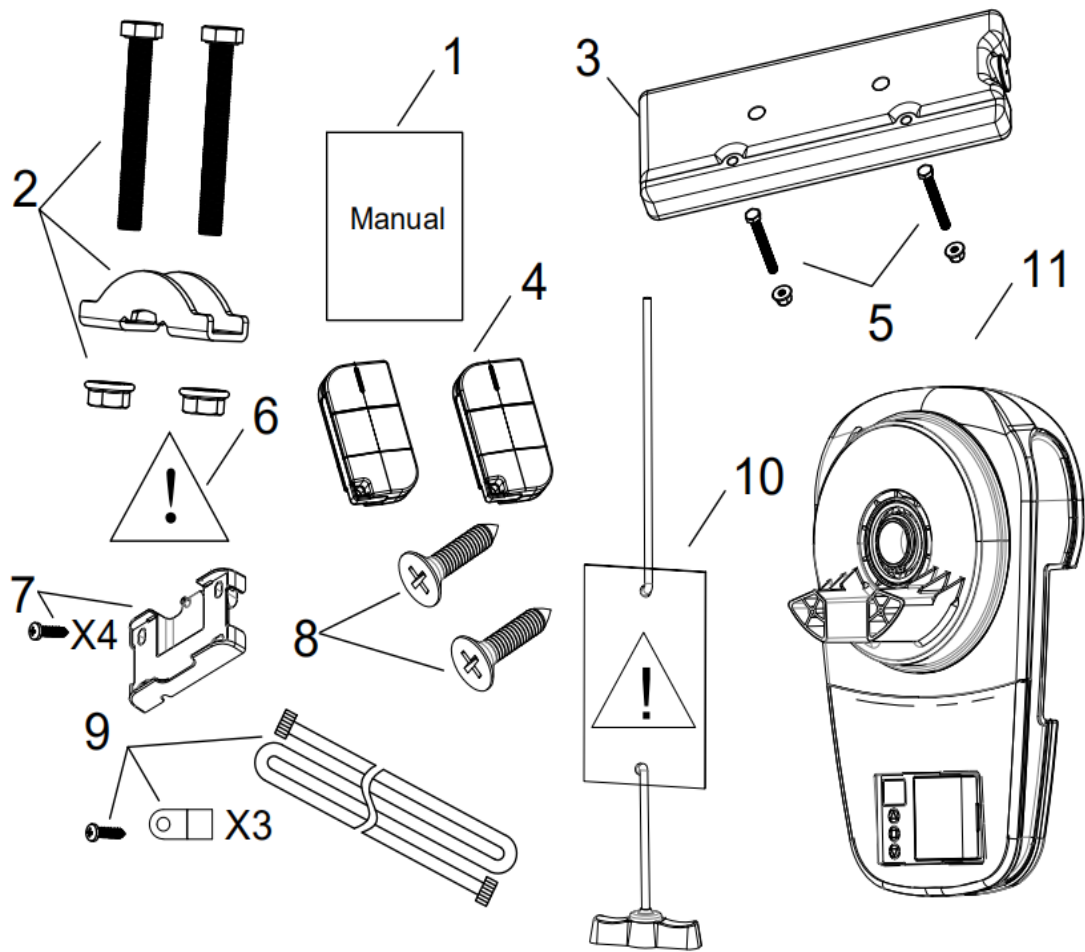

2.TOOLS REQUIRED

1. Marker pen
2. Adjustable wrench for U-bolts already installed on the door (2)
3. Philips-head screwdriver
4. Rope

Installation Instruction and User Guide

5. Drill and 6.5mm drill bit

6. Ladder

7. 8mm, 10mm, 13mm sleeve 300mm extension sleeve (for narrow side mounting) and socket wrench

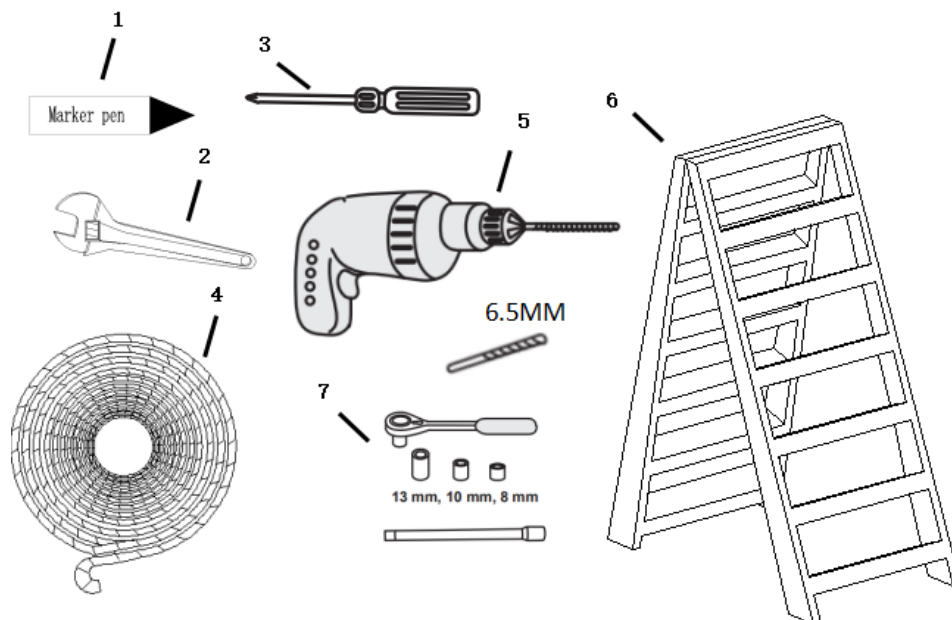

3.DOOR REQUIREMENTS

1、 Maximum door weight of 130 kg.

2、 Maximum door height of 5 m.

3、 Maximum curtain area of 20 m².

4、 Protector System (Photo cell) must be installed if the force at the edge of closing Door exceeds 400N (40 kg)

5、 Applicable to door shaft diameter range is

$$34^{+1}_{-0.5}\text{mm}/32^{+1}_{-1}\text{mm} \text{ (Optional) }。$$

6、 Ensure that there is at least 40 mm from edge of

the curtain to the edge of the bracket.If the clearance is small, the rolling door opener cannot be installed, please increase the clearance before installation.

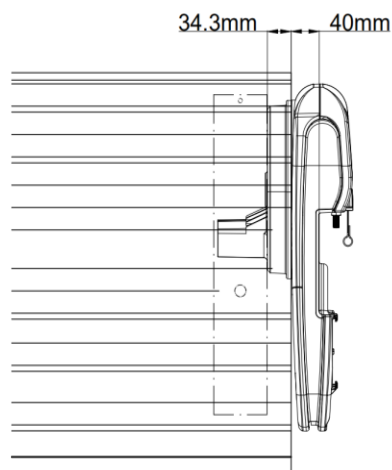

Installation Instruction and User Guide

Note: Main Opener body thickness: 88mm (Not including wheel drum). Motor Opener body thickness after lithium battery installed: 93mm (Not including wheel drum).

4.PRE-INSTALLATION RECOMMENDATIONS

Please complete the following test under no other force than the torsion force of the door spring to ensure good balance of the door:

- 1、 Raise and lower the door to determine if there are any sticking or binding points (20 kg is the absolute maximum allowable to raise or lower the door in any position).
- 2、 Do not lock the roll door or remove any rope connected to the roll door.
- 3、 Lift the door about halfway up and then release it. The door should be balanced by the spring rebound.
- 4、 Before installing the motor, if the roller door is not balanced in place, a qualified roller door installation technician is required.

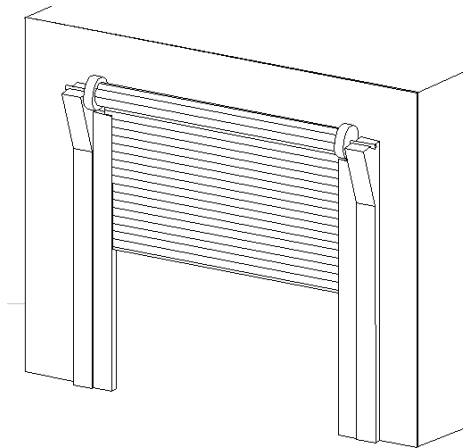

Note: This motor shall not be installed in a damp space or exposed to the outdoors. After installation of the roll door, ensure that the part of the roller door is not extended on the public or pavement. The motor shall not be installed on the roll door with a pass-door.

5.ATTACHING THE WEIGHT BAR

If the door has a lifting handle, remove the handle, nuts&bolts. Place the weight bar over the handle holes,insert the extended bolts through the weight bar & fasten the handle back in place.

Place the weight bar in the centre of the door as shown.

If the door curtain does not have a handle you will need to follow these instructions:

- 1、 Use a marker pen to mark the two hole positions.

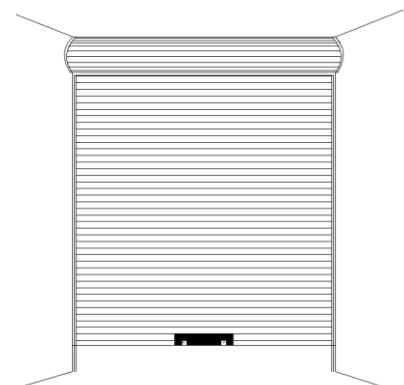

Installation Instruction and User Guide

2、 Drill two 6.5mm holes through the two marked positions, then place the weight bar on the inside of the door.

3、 Use the bolts, washers and nuts(provided) to fasten the weight bar in the drilled place.

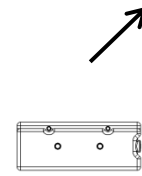

6.CURTAIN FIXING(IF REQUIRED)

Note: To make sure whether the curtain and drum wheel fixed by two screws or more, if not, in order to there is no balloon, insert the supplied self tapping metal screws into where the curtain leaves the roll. Secure these through the curtain into the drum wheel at each end of the roll.

First, close the door curtain under normal conditions and there is no balloon on the top of the door curtain, use a second self-tapping screw to fix it at a semicircle away from the first screw fixing position, as shown in the figure.

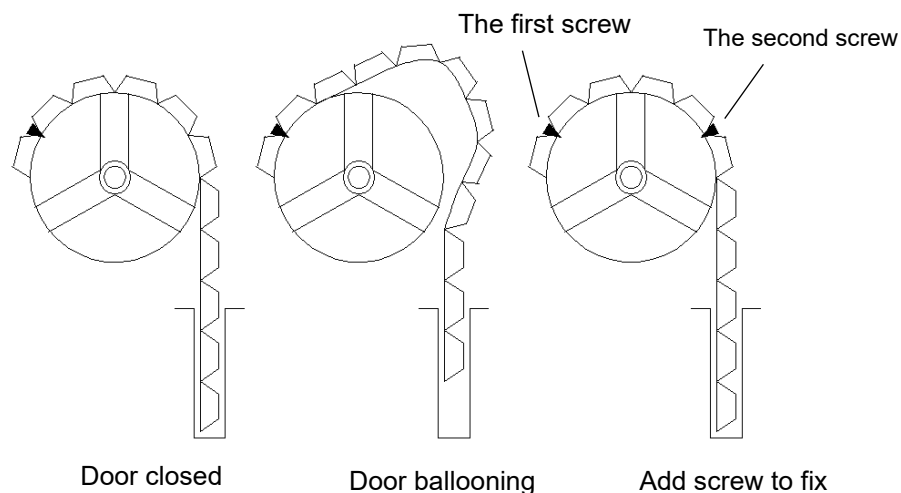

7.THE RELEASE HANDLE & CORD

The manual release mechanism enables the door to be manually operated during power outages or in an emergency locking.

1、 Please install the provided clutch extension cord to the ring-pull of the opener and ensure it is firm.

2、 When the power outage, please release the handle, so that the

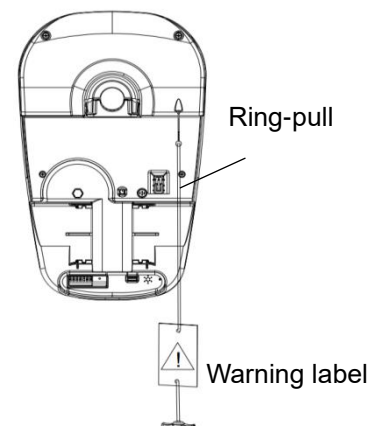

Installation Instruction and User Guide

door can be controlled by hand.

3、 The RED Manual Release cord is preassembled to the opener.

When the opener is installed the handle should be no higher than 1.8 metres from the floor. The cord may need to be extended for high door installations.

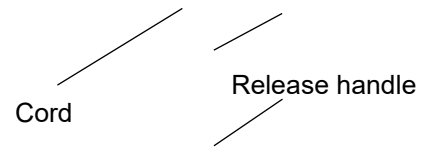

8.OPERATING THE MANUAL RELEASE

Note: Be careful when operating the clutch, because if the torsion spring fails in the door, the door will momentarily close when the clutch is released, which may cause personal injury and property damage;

Release the clutch: When the clutch is locked, pull the clutch handle down manually. When you hear a click sound then release the clutch handle, the clutch is released and you can manually open and close the door.

Locking the clutch: When the clutch is released, pull the clutch handle down manually. When the clutch handle is released when a click sound is heard, the clutch is locked and the door motor can be used to open and close the door.

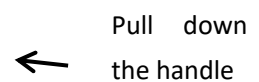
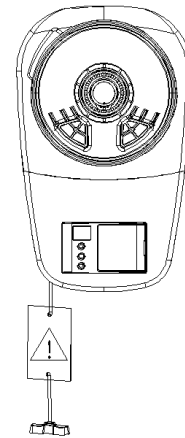

Installation Instruction and User Guide

9.LEFT/RIGHT SIDE INSTALLATION

LEFT

(Install in this direction to switch installation direction before function setting, for the switching procedure, please refer to section 2-7 in section 13)

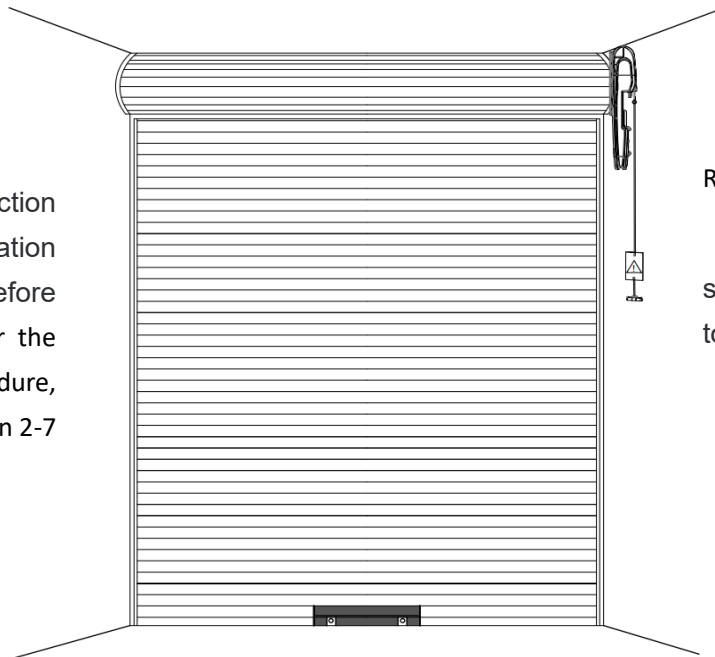

RIGHT

(factory default setting, no need to adjust)

Inside garage looking out

10.ATTACHING EXTENSION BAR (IF REQUIRED)

If the drive leg does not touch the roll door and reel spokes, the extension poles needs to be installed:

- Insert the extension poles into the drive legs.
- Align the holes on the extension poles with the holes on the drive legs.
- Using the screws provided, secure the extension poles.

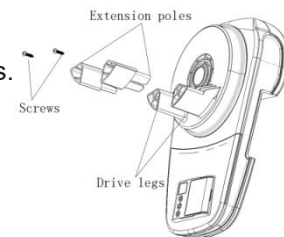

11.INSTALLATION PROCEDURE

Note: The opener can be installed on either side of the door. The following instructions are for **RIGHT HAND INSTALLATIONS**.

- Ensure the saddle U-BOLT at the end opposite opener side are securely fastened.

Installation Instruction and User Guide

- Completely open the roller door. Tie the safety rope in the middle of the door. Do not tie the rope too tightly to avoid damage to the door.
- Mark the position of the door axle on the bracket, use a ladder or a suitable pillar to support the roller door, and then open the saddle U-BOLT on the opener mounting end side to unload the bracket.
- After release the opener clutch, the opener sungear assembly can rotate freely and then slide the opener over the door axle and engage the drive legs into the door drum wheel, push the opener sungear assembly as far as possible (without disturbing the roller door) and ensure that one of the reel spokes is completely between the sungear assembly axle or extension poles of the opener.
- Refit the door mounting bracket to the wall.
- Clamp the opener on the door axle in the marked position using the clamp assembly supplied (tighten to 28 – 30 Nm).
- Remove all ropes and the support stand.
- Check the operation of the door in manual mode by raising and lowering by hand. It should operate smoothly without sticking or binding.

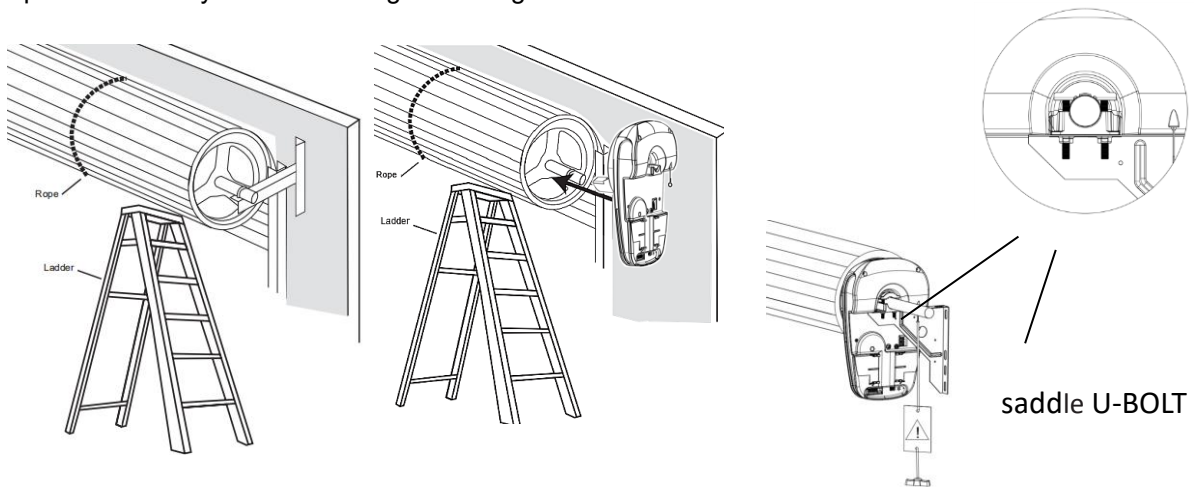

12.INSTALLATION CONTROL BOX(IF REQUIRED)

- The control box needs to be disassembled on the rolling door motor by itself(Plug-in) Disassembly requires careful operation. Violent disassembly may cause damage to internal interfaces or other components.

Installation Instruction and User Guide

- Choose a suitable position on the wall and fix the wall bracket with screws.
- Connect the control box and the roller door motor with a connecting cable, and then put the control box in the corresponding position of the wall bracket.
- Use the cable buckle to fix the cable on the wall to ensure that the cable does not interfere with the operation of the door

Note: Be careful when determining the installation height of the control box to prevent personal injury and property damage caused by children's misuse.

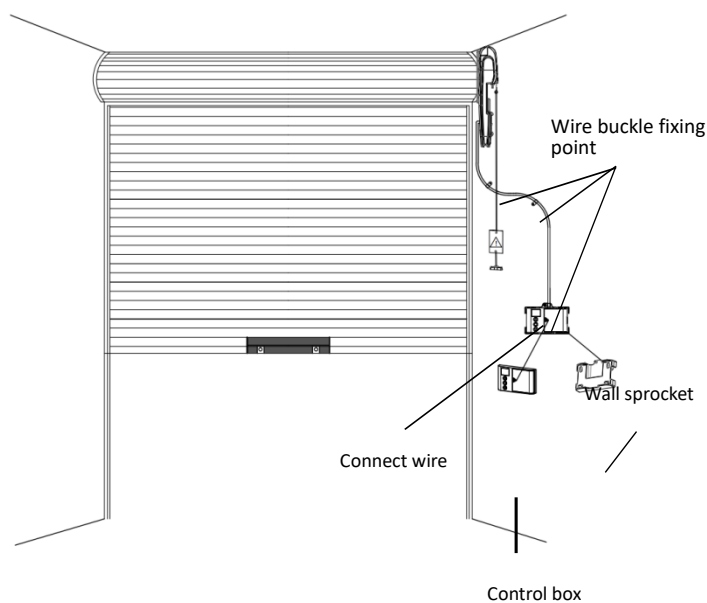

13.CONTROL PANEL INSTALLATION MANUAL

Explanation:

1. FC, 99-00 countdown is displayed for the first time, and the L and R indicators are on.

Standby display:



- 1.No stroke standby display
- 2.Motor has stroke cycle display



....

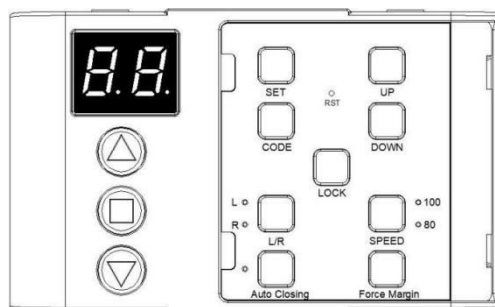

Installation Instruction and User Guide

(001234 indicates that the opener runs 1234 cycles)

● Buttons instruction:

SET :confirm / enter menu settings.

CODE: code the remote/ cancel code/menu setting interface exit function.

UP/Δ: open the door/stop/menu interface function option switch.

□:stop.

DOWN/∇: closing the door/stop/menu interface function option switch.

RST: restore factory settings.

LOCK: remote lock close/open setting.

L/R: left/right installation method setting.

L/R LED: LED lights up to indicate left / right installation status.

SPEED BUTTON: door closing speed switching (It cannot be switched continuously. After the adjustment is completed, the door opening and closing must be triggered manually).

100/80 SPEED LED: 100 means the door opening and closing speed is 100%, 80 means the door opening speed is 100% and the door closing speed is 80%.

AUTO Closing: auto closing setting (LED lights up to indicate mean the auto closing function is opening) .

Force Margin: automatic reverses setting.



● Quick function operation instruction



1、Open/close control (control panel): Click Δ/UP button (open/stop) 、click □ button (stop) 、Click∇/DOWN button (open/stop) ;

2、Menu Settings: Long press the SET button;

Installation Instruction and User Guide

3、 Remote control code: Standby status click the CODE digital tube to display . Enter the code checking state, press the same button of the remote control continuously for two or three times, and then the two dots of the digital tube flash quickly and the polite light flashes, which means the code checking is successful (the default remote control storage quantity is 50);

4、 Clear code of remote control: Standby state long press CODE, digital tube two small points flash , Until the digital tube displays , all stored remote controls will be deleted;



5、 Maintenance alarm remaining times inquiry: Long press DOWN for 6 seconds, and the buzzer will sound, waiting for the digital tube to display . Release the button and the digital tube displays a loop in turn, such as ... (This means that the number of remaining maintenance alarms is 1234) , And then automatically back to standby display;

6、 Remote control lock setting: Click the LOCK button to switch (Standby status: digital tube displays  this means that the lock function of the remote control is turned on and the remote control is disabled, Press again, and the lock function of the remote control is turned off) ;

7、 Left/right installation Settings: Press the L/R button for 6 seconds, Release the button after switching the status of L/R LED indicator (Note: in the garage from the inside out, to distinguish the left and right direction, the default is right, each time the left and right installation state, need to relearn the trip.)

8、 Speed adjustment Settings: Long press the SPEED button for 4 seconds when the door is closed, the indicator light will change state, the buzzer will sound, and the door body will turn on and off automatically once, open and close the door manually again (100 is the speed of opening and closing 100%, 80 is the speed of opening and closing 100% closing speed 80%, not continuous switching.) ;

9、 Automatic closing setting: Click the AUTO Closing button to switch (The default LED light off means that the automatic closing function is off, the LED light on means that the automatic closing function is on, the default automatic closing time is 15 seconds) ;

10、 Rebound setting: Press the Force Margin button, the digital tube is displayed in turn  ...  choose the right gear for the nine - gear adjustment (The factory default is L3, and the rebound value increases gradually from L1-- L9) ;

11、 Restore factory Settings: Long press the RST key for 4 seconds and the digital tube will

Installation Instruction and User Guide

scroll **F_** **F_** **F_** and roller door opener will restart (Motor operation times, maintenance alarm times, the learned remote control is not within the scope of factory settings)

Press the RST button for a long time with a needle-like object less than 2mm in diameter, and the digital tube will be displayed as shown in the figure. Then release the tube and wait for the motor to restart to restore the factory setting

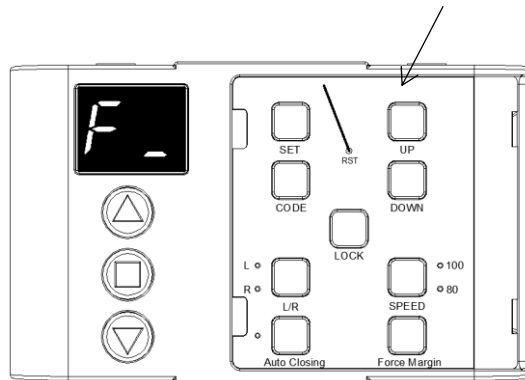

14.FUNCTIONAL SPECIFICATIONS

Note: before setting the stroke, please release the clutch and manually lift the door to the middle position. Once again confirm whether the left/right side of the motor is installed correctly, then lock the clutch, so as to prevent the door body from being damaged in the process of setting the stroke due to the wrong installation setting of the left/right side of the motor or the door body being in the upper/lower limit position.

► Motor stroke setting



Long press the SET button to enter the menu interface1.-

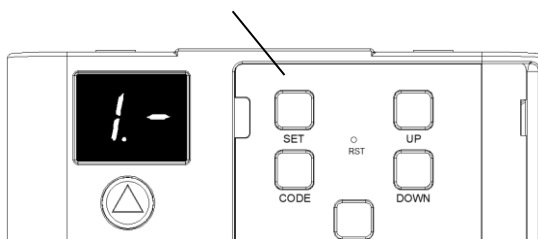

Function set limit learning

a: Long press the SET button until the digital tube displays **1-**; release button.

b: Click SET again to confirm, enter limit learning mode, digital tube displays **17**

Installation Instruction and User Guide

Press SET to enter the upper limit setting interface

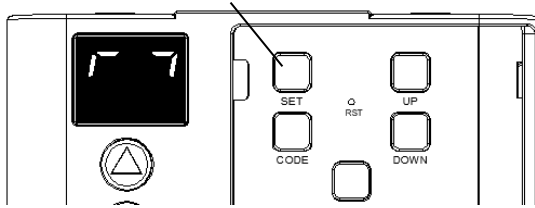

Press UP to set the upper limit (click UP or DOWN to fine

tune UP and DOWN)

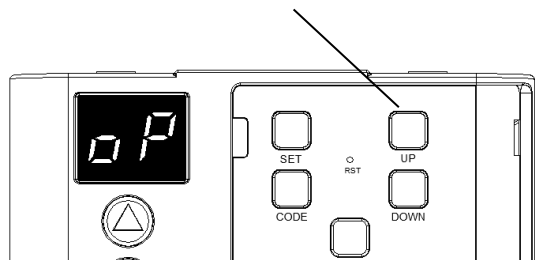

After the upper limit is set, click SET button to enter the lower limit setting interface.

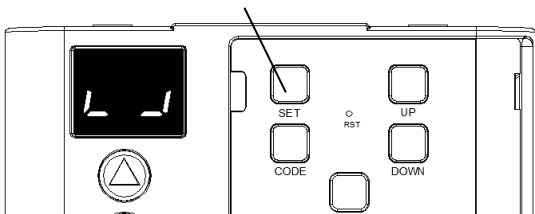

Press DOWN to set the lower limit (click UP or DOWN to fine tune UP and Down).

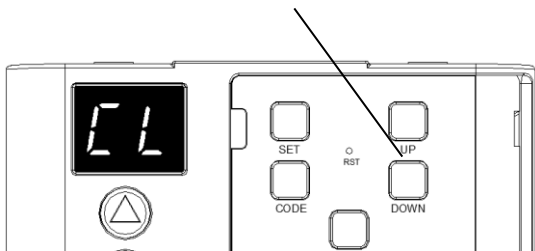

After the lower limit is set, click the SET button to return to the standby interface.

d:Press SET button to confirm and store the upper limit of the door, then the digital tube displays **09** press and hold DOWN button to close the door and the digital tube will display **EL** down to close the door until it reaches the desired position (click UP and DOWN to fine-tune).

After determining the lower limit, press SET button to confirm the closing position. After the lower limit is determined, the door will automatically return to standby display. The door will open and close the cycle and run the full stroke once. The force value data in the process of running the door will be learned.

To this door body can operate normally.

Installation Instruction and User Guide

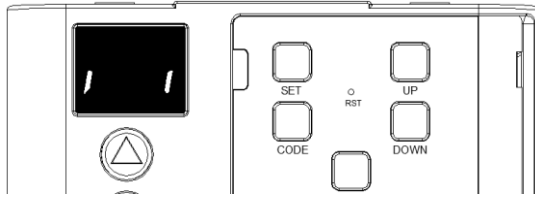

► Motor slow stop function

(Reduce the impact of sudden stop on the door body during normal operation)

Long press the SET button to enter the menu interface1.-

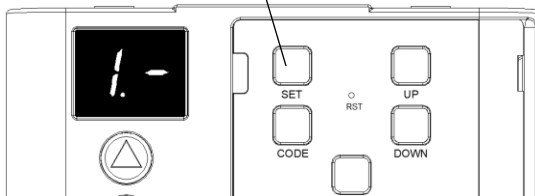

Click UP or DOWN to switch to 2.- function menu options interface

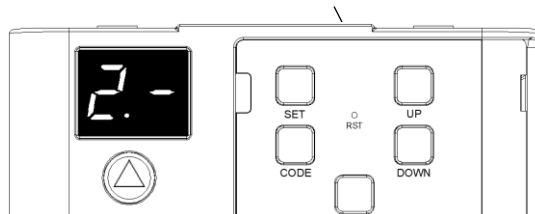

Slow stop function during motor operation

Note: this function is for the motor to slow down and then stop when the stop command is triggered during the motor running at full speed to reduce the impact on the door mechanical structure

- Hold down the SET button for a while until the digital tube displays , then through the UP or DOWN button to fine adjustment, digital



Installation Instruction and User Guide

Click SET to enter the interface of speed adjustment and selection

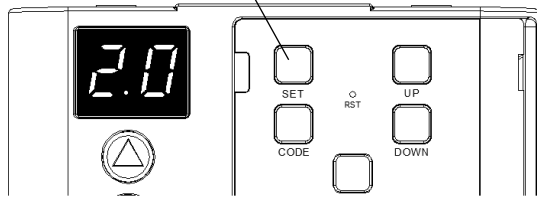

Example: click UP or DOWN to switch to 2.1, then the motor will slow DOWN to 50% speed and stop after receiving

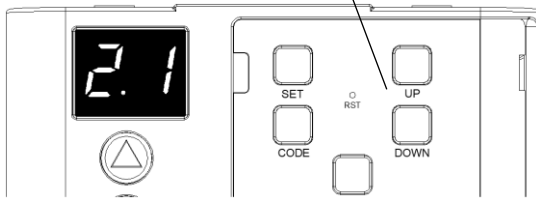

Click the SET button to return to the standby screen

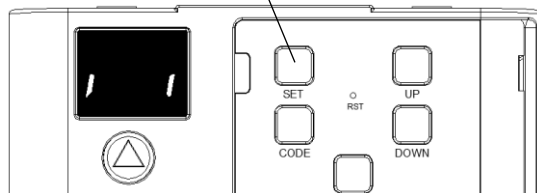

b. Press SET button again, enter the sub-menu, digital tube displays **2.0**, enter the running process and stop the caching function.

c. Adjust by UP or DOWN button **2.0** means the motor stops immediately upon receiving the stop command (the factory default).

2.1 means after receiving the stop command, the motor first slows down to 50% speed and then stops.

2.2 means after receiving the stop command, the motor first slows down to 40% speed and then stops.

2.3 means after receiving the stop command, the motor first slows down to 30% speed and then stops.

2.4 means after receiving the stop command, the motor first slows down to 20% speed and then stops.

d. Press the SET button to confirm speed selection and return to standby interface automatically.

Note: factory setting speed is **2.0** when the motor receives the stop command, it stops immediately. When this function is turned on, the remote control will trigger the opening and closing of the door, which will not stop

Installation Instruction and User Guide

► Automatic closing time and condition setting

3.-

Long press SET button and enter menu interface 1.-

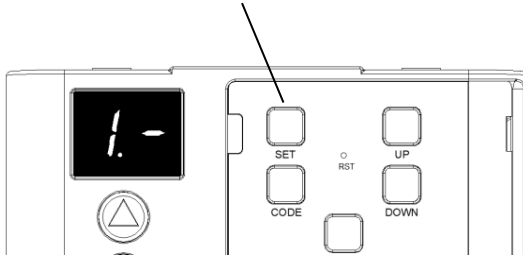

Click UP/DOWN button to switch to 3.- function menu

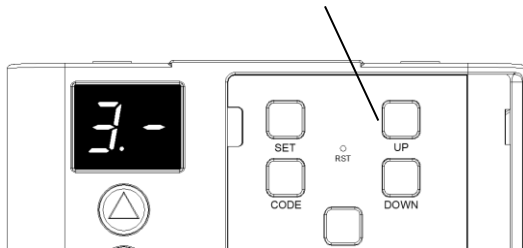

Click the SET button to enter auto closing time setting menu (Factory standard is set on 03)

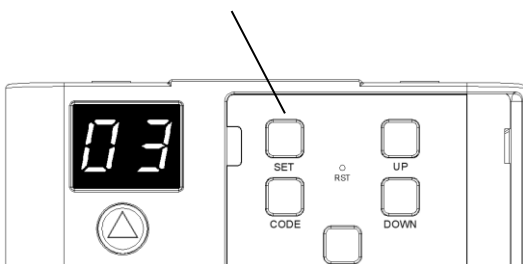

After the auto closing time is selected, click the SET button again to confirm and enter the auto closing condition setting (Factory standard is set on 3.1)

Automatic closing function time

NOTE: AUTO closing function switch is set by AUTO Closing

a, Long press SET button till the display board show 1.-, then press UP or DOWN to choose, till display board show 3.- (Automatic closing function main menu)

b, Press SET button to confirm and go to sub-menu, then the display board show 03

c, Setting the AUTO closing time grade from 01-to-99 by press UP/DOWN button, 5S for each grade.

AUTO closing time = 5S*n, n=01—99.

The maximum closing time : 495S

d, Press SET button to confirm again then enter the menu for AUTO closing condition setting, display board show 3.1. Press UP/DOWN

button to choose between 3.1 and 3.2.

3.1 means, the door only can auto close while in the open limit position and start closing counting.

3.2 means, the door can auto close while the door is in any position and start closing counting.

e, Press SET button to confirm the set and it will back to standby status.

Installation Instruction and User Guide

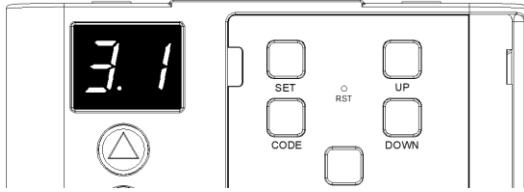

For example: Switching to 3.2 by press UP/DOWN

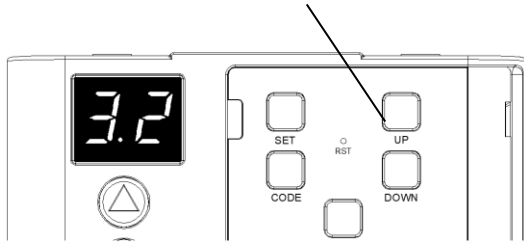

Press SET button to confirm the set an it will back to standbv status

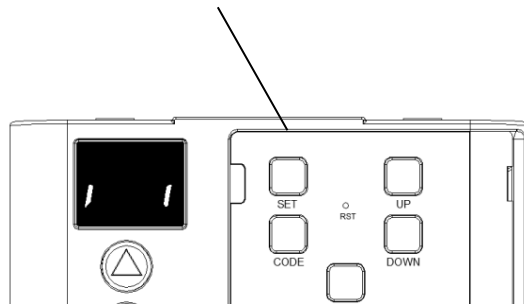

3.The closing condition is set on **3.1** as standard in factory.

4.LED light flashes while the door is going to close.

5.If the door controlled by remote or panel during the closing process, the door will no longer close automatically.

Note: In order to ensure the safety of use, the

► LED off delay time setting **4.-**

Long press SET button and enter menu interface 1.-

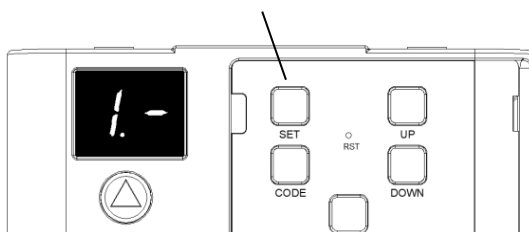

Click UP/DOWN button to switch to 4.- function menu

LED off delay time setting

a,Long press SET button till the display board show **1.-**, then press UP/DOWN to choose, till display board show **4.-** (LED OFF DELAY TIME SETTING MENU)

b,Press SET button to confirm and go to sub-menu, then the display board show **4.3**

Installation Instruction and User Guide

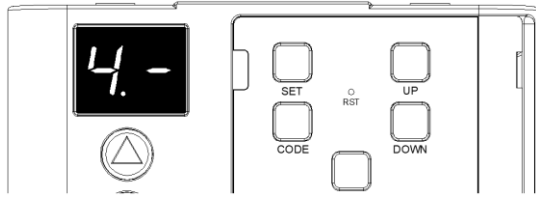

Click the SET button to enter LED off delay time setting menu(Factory standard is set on 4.3)

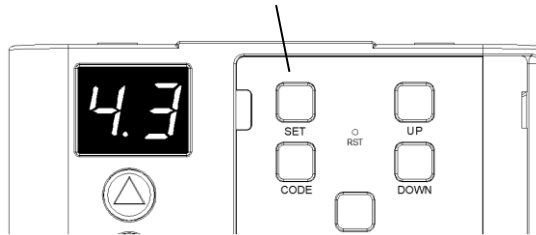

For example: click UP/DOWN button to choose 4.9, it means LED off delay time is $9 \times 1 \text{min} = 9 \text{mins}$

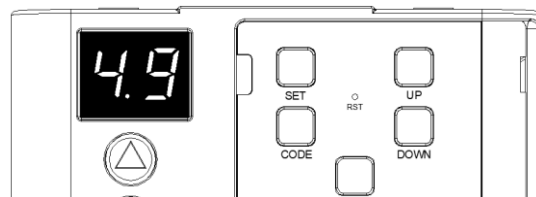

Press SET button to confirm the set and it will back to standby status

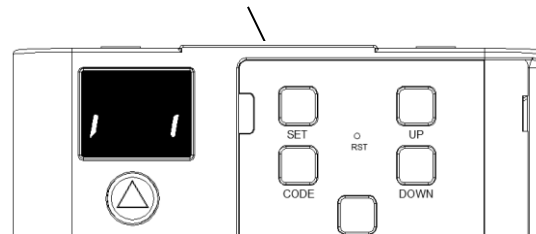

Installation Instruction and User Guide

► Partial open/height setting **5.-**

Long press SET button and enter menu interface 1.-

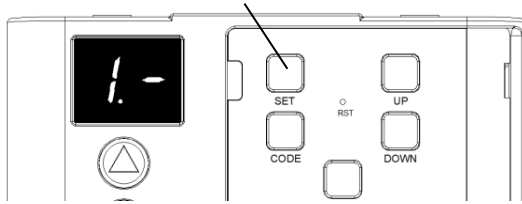

Click UP/DOWN button to switch to 5.- function

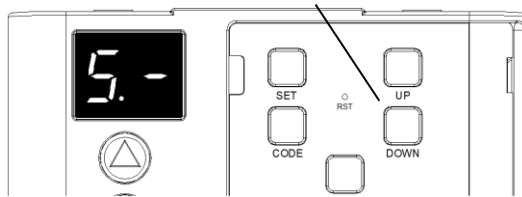

Click the SET button to enter PARTIAL OPEN/HEIGHT SETTING menu(Factory standard is set on 5.0)

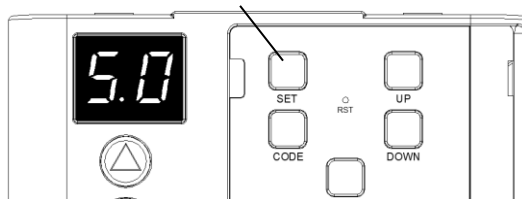

For example: click UP/DOWN button to choose

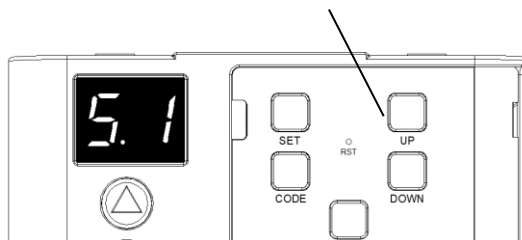

Press SET button to confirm the set and it will back to standby status

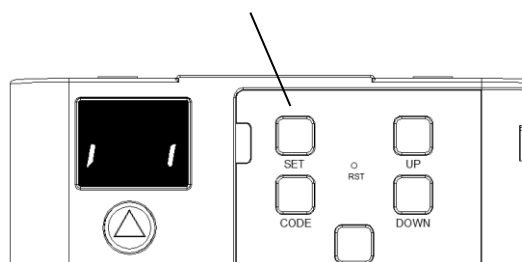

Partial open/height setting

a, Long press SET button till the display board show **1.-**, then press UP/DOWN to choose, till

display board show **5.-** (PARTIAL OPEN/HEIGHT SETTING)

b, Press SET button to confirm and go to

sub-menu, then the display board show **5.0**

c, Setting the PARTIAL OPEN/HEIGHT SETTING

grade from **5.0** to **5.9**

5.0 means: close the partial open function.

5.1 to **5.9** It indicates the percentage of the set open position in the whole travel.

5.1 means the door open height is 10% of the whole travel.....

5.9 means the door open height is 90% of the whole travel

d, Press SET button to confirm the set and it will back to standby status.

Note: 1, The partial open/height is set on **5.0** as standard in factory.

2, When the partial open/height function is on and there are four buttons with your remote. If you coded with the first remote button successful, press the first remote button, the door will open fully, and press the second remote button, the door will open to the position you have chosen.

3, This function is only effective by remote control, when the door bracket is lower than the height of

Installation Instruction and User Guide

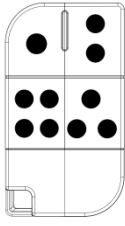

Remote control button

corresponding number as fig

Remote button note: the 1 button & 2 button as a kit, the 3 button & 4 button as a kit.

Installation Instruction and User Guide

► Photo cell on/off setting **6.-**

Press and hold SET Button until 1.- appears on the display

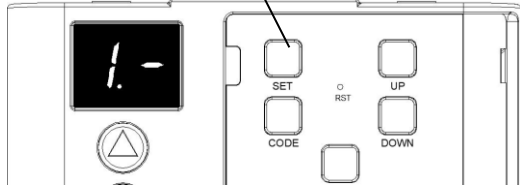

Press UP or DOWN switch to 6.- Function menu option interface

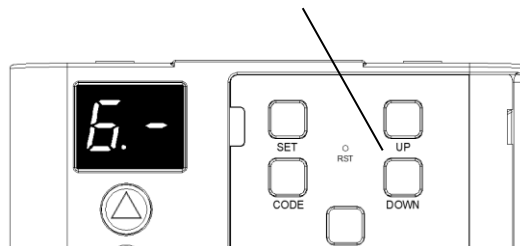

Press SET to enter the PE function interface setting option interface (Example: The default 6.0 means that the PE function is closed)

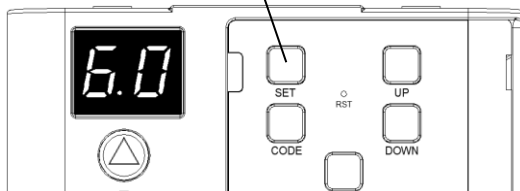

Example: If the PHOTO CELL DEVICE is installed, Press UP or DOWN to enter switch to 6.1, means that the PE function is open)

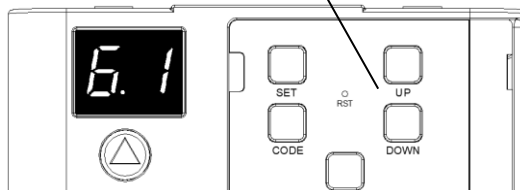

Press SET button to confirm the set and it will be back to standby status automatically and display ||

Photo cell on/off setting

NOTE: Our roller door opener need to use the normally closed status NC photo cell device, and need to be connected to PE of opener (Make sure the photo cell has been correctly installed and used Normally closed contacts to the accessory terminals of the opener. Also note that the photo beam function must be disabled if NO photo beams are fitted, otherwise the door cannot be closed, and the LED display will show the letter **EE** as an indication).

a, Press and hold SET Button until appears on the display **1.-**, next press the UP/DOWN button until appears on the display (PHOTO CELL ON/OFF SETTING).

b, Press the SET button again to enter ON/OFF setting, then you will see **6.0** appears on the display.

c, Press UP/DOWN button to set the photo cell function ON/OFF switch.

6.0 means: the function interface is closed.

6.1 means: the function interface is open.

Installation Instruction and User Guide

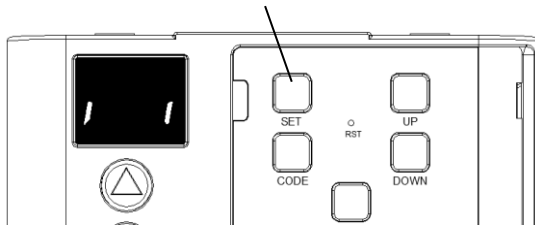

Installation Instruction and User Guide

► Remote buttons recognition function setting **7.-**

Press and hold SET Button until 1.- appears on the display

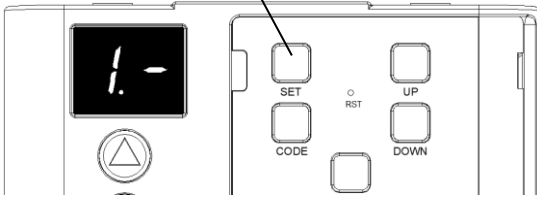

Press UP or DOWN switch to 7.- Function menu option interface

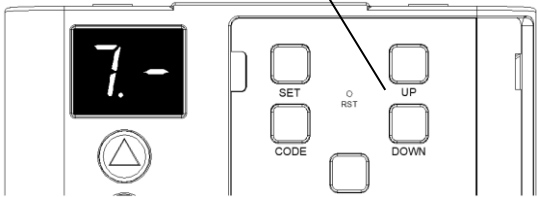

Press SET to enter the remote buttons function setting option interface (Example: The default 7.0 means that the remote buttons recognition function is open)

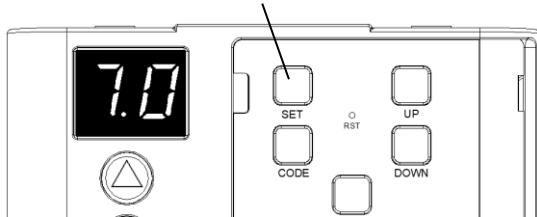

Example: Press UP or DOWN to enter switch to 7.1, means that the remote buttons recognition function is closed)

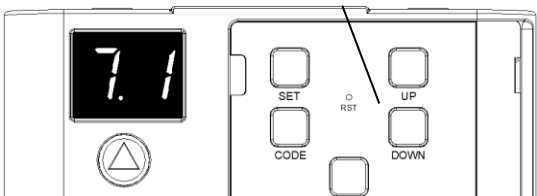

Press SET button to confirm the set and it will be back to standby status automatically and display ||

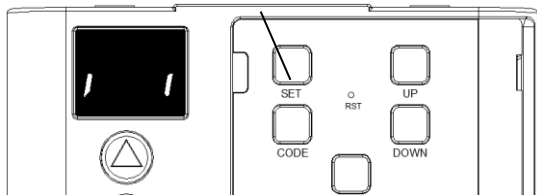

Remote buttons recognition function setting

a, Press and hold SET button, until **1.-** appears on the display, next press the UP/DOWN button until **7.-** appears on the display

(REMOTE BUTTONS RECOGNITION FUNCTION).

b, Press the SET button again to enter ON/OFF setting, then you will see appears on the display **7.0**.

c, Press UP/DOWN button to set the remote buttons recognition function ON/OFF switch.

7.0 means: the remote buttons recognition function is open. (It means if you coded first button with first opener, then the first button will be the only button on the remote can control the opener).

7.1 means: the remote buttons recognition function is closed (It means if you coded 1 button with 1 opener, then all the 4 buttons on the remote can control the opener).

d, Press SET button to confirm the set and it will

► Maintenance alarm operation cycles count setting **8.-**

Press and hold SET Button until 1.- appears on the display

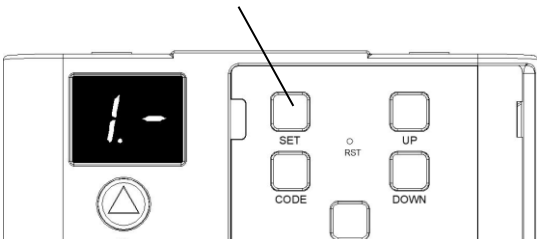

Maintenance alarm operation cycles count setting

a, Press and hold the SET button until **1.-** appears on the display, next press the UP/DOWN button until **8.-** appears on the display counting

Installation Instruction and User Guide

Press UP or DOWN switch to 8.- Function menu option interface

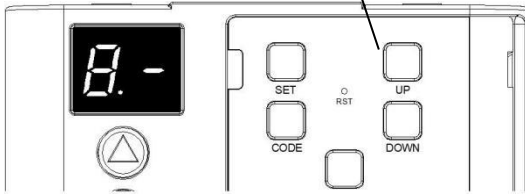

Press SET to enter the maintenance alarm function setting option interface (Example: The default 8.0 means that the maintenance alarm function is closed)

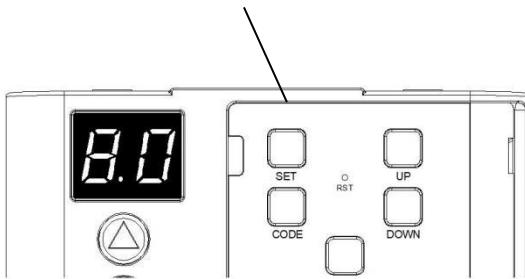

Example: Press UP or DOWN to enter switch to 8.9, means the maintenance alarm count cycle is set on $9 \times 500 = 4500$ times)

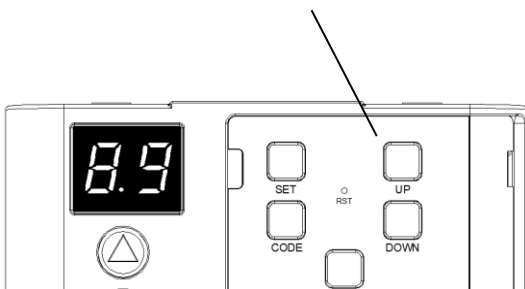

Press SET button to confirm the set and it will be back to standby status automatically and display ||

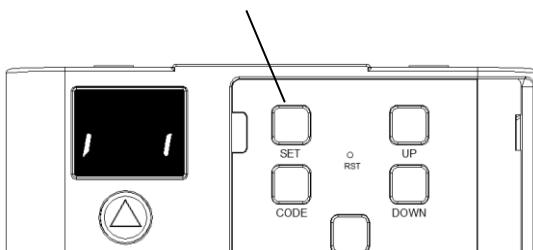

b, Press the SET button again to enter the opener maintenance alarm setting, the appears on the display is **8.0**, then press the UP/DOWN button to adjust menu **8.1** to **8.F**

8.0 means: the maintenance alarm function is closed (standard in factory)

8.1 means: the maintenance alarm count cycle is set on $1 \times 500 = 500$ times ...

8.9 means: the maintenance alarm count cycle is set on $9 \times 500 = 4500$ times

8.A means: the maintenance alarm count cycle is set on $10 \times 500 = 5000$ times

8.F means: the maintenance alarm count cycle is set on $15 \times 500 = 7500$ times

(From 1 to F, each increase of 500 times is $N \times 500$)

c, Press SET button to confirm the set and it will be back to standby status automatically

REMARK: When you restart the factory standard the counter is not cleared

Maintenance alarm explanation (Each time the lower limit the times will minus 1)

When the maintenance alarm times is 0, every time the opener runs to the upper and lower limit, the LED light will flash quickly, the buzzer will continuously vibrate, that means the door need to maintenance and the appears on the display is

Installation Instruction and User Guide

15.SAFETY REVERSE TEST

1、 Safety reverse test system steps:

Place an obstacle of about 40mm between the floor and the garage door and close the door downward. The door must be inverted when the obstacle is in contact with the rolling door. If the door is stopped on the obstacle, the safety rebound system is not qualified.

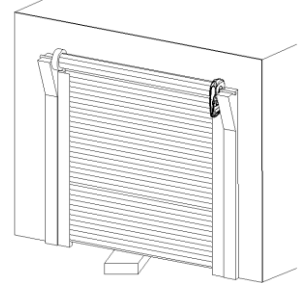

2、 Repeat safety reverse system test until qualified.

Note: if the motor is not adjusted correctly, it may cause serious injury to people or objects when the garage door is closed.

The height of the cushion block is 40mm

Installation Instruction and User Guide

16.DESCRPTION OF EXTERNAL PORT

- **Photo cell connection (optional) -- figure 1**

Remark:

1. Photo cell device should be less than 2W.
2. PE (external port) is normally closed.

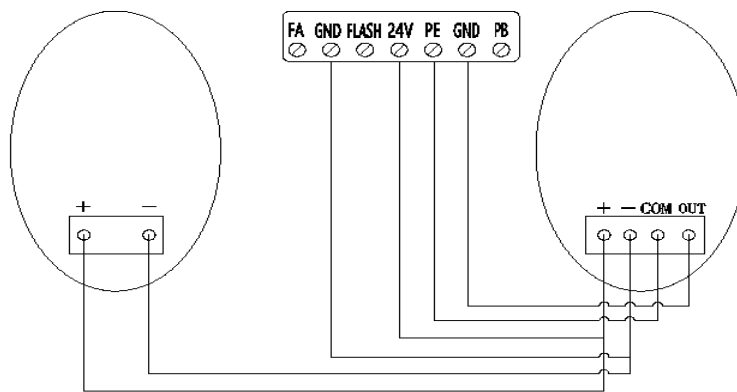

Photo cell connection

Figure 1

- **Other terminal introduction and application**

1. PB interface (the interface is "normally open" wiring as shown in figure 2) is used to add a new O/S/C button to open or close the volume door.
2. The FLASH interface is the warning light function interface (wiring is shown in figure 2). This port has provided corresponding 24V FLASH light voltage (24V warning light can only be used).
3. FA interface (the interface is "normally open") is the fire alarm function (wiring is shown in figure 2).

Installation Instruction and User Guide

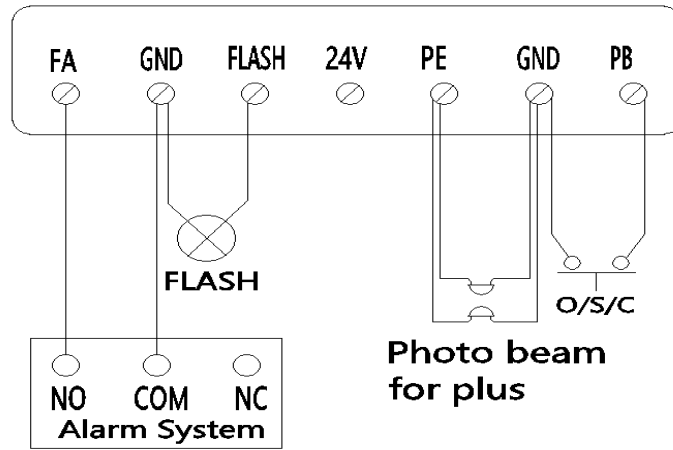

Figure 2









17.SPECIFICATION

Input voltage	AC220~240V/50-60Hz
Max. tension	800N @ø300MM
Max. door size	20 m ²
Max. door load	130Kg
Max. door height	5.0M
Model	24V DC
Working frequency	433.92MHz/868.35MHz Optional
Working temperature	-20°C~50°C
Rated load	45N.M
Maximum chuck speed	8.5r/min
Code compatibility format	Rolling code (HCS300/HCS301 data format)

18.FAULT ALARM DISPLAY CODE,CAUSE AND SOLUTION

Opener running code

Installation Instruction and User Guide

Fault appearance code	Fault description	Solutions
	Encoder failure	Replace encoder
	Opener running signal can not be detected	1, Check whether the connection between the limiter and the control board is loose. 2, Gear motor failure. 3, Trolley assy in loose state, lock trolley assy.
	The positive and negative terminals of the gear motor are reversed	Reinsert the positive and negative motor wiring rightly
	Insufficient opener power supply	It maybe caused by the unbalanced door or the door does not match the opener, but it doesn't affect the opener normal use.
	Opener overload alarm	The door is completely jammed, so that the opener can not learn the travel.
	Fire alarm function trigger.	It just can be released after the fire alarm to reset.
	Photo cell function triggered	The infrared radiation is blocked, or the NC / NO connection of the port is wrong
	Maintenance alarm period for the door has expired	Inform maintenance person to maintain the door
	Travel learning failure	Relearn the travel

19.COMMON FAULTS & SOLUTIONS

Fault appearance	Fault cause	Solutions
No any working for openers LED screen is not bright	1. Power supply failure 2. Plug wire is losing	1. Check whether the opener socket is energized. 2. Check whether Fuse tube is broken. 3. Check whether the low-voltage wire

Installation Instruction and User Guide

		<p>of transformer is connected to the power board.</p> <p>4. Check whether there is 26V AC at the transformer low-voltage side, if there is 26V AC, replace the PCB. If not, replace the transformer.</p>
Position missing	System error	Re-set the limit traveling
LED is always on	The control panel is broken or the power supply board is broken	Replace the control board or power board.
Door is automatically reversed to the upper limit before the door closed completely	In operation with automatic reverse function, the door is not installed correctly, there is some blocks on its moving	<ol style="list-style-type: none"> 1. Check the block position of the door and re-set the limit traveling 2. Increased force number for automatic reverse.
Door automatically stops while opening	In operation with automatic protect function when obstruction is detected. The door is not installed correctly. There is some block on its moving.	Check the block position of the door and re-set the limit traveling
The remote control cannot be used or the operation distance is short.	<ol style="list-style-type: none"> 1. Flat battery. 2. Antenna is loosed or not well extended 3. Interference around nearby. 	<ol style="list-style-type: none"> 1. Replace new battery 2. Extended the antenna on the opener. 3. Get rid of interference.
Cannot code in the new remotes	New remote control is not compatible with opener	4. Choose our remote control only
The battery do not supply power	<ol style="list-style-type: none"> 1. Flat battery 2. The battery wire is plugged inversely 3. The battery wire is broken 	<ol style="list-style-type: none"> 1. Charge the battery 2. Open the cover, check "+" "-" of the battery 3. Replace the battery wire
Other abnormal	External devices is not	Remove all the external devices. If the abnormal issues still exist, replace the

Installation Instruction and User Guide

issues	compatible with the opener	circuit board
--------	----------------------------	---------------

20.PARTS LIST

Item	Description	Item	Description	Item	Description
1	Sungear assembly	7	Transformer	13	Connect cable
2	Upper housing	8	Trolley release cord	14	Power cable
3	Chassis sub-assembly	9	Wall bracket	15	Extend arm (Optional)
4	Drive board	10	24V power socket	16	Fuse
5	Front lower housing assembly	11	LED cover		
6	Operation panel (control box)	12	Base housing		

Installation Instruction and User Guide

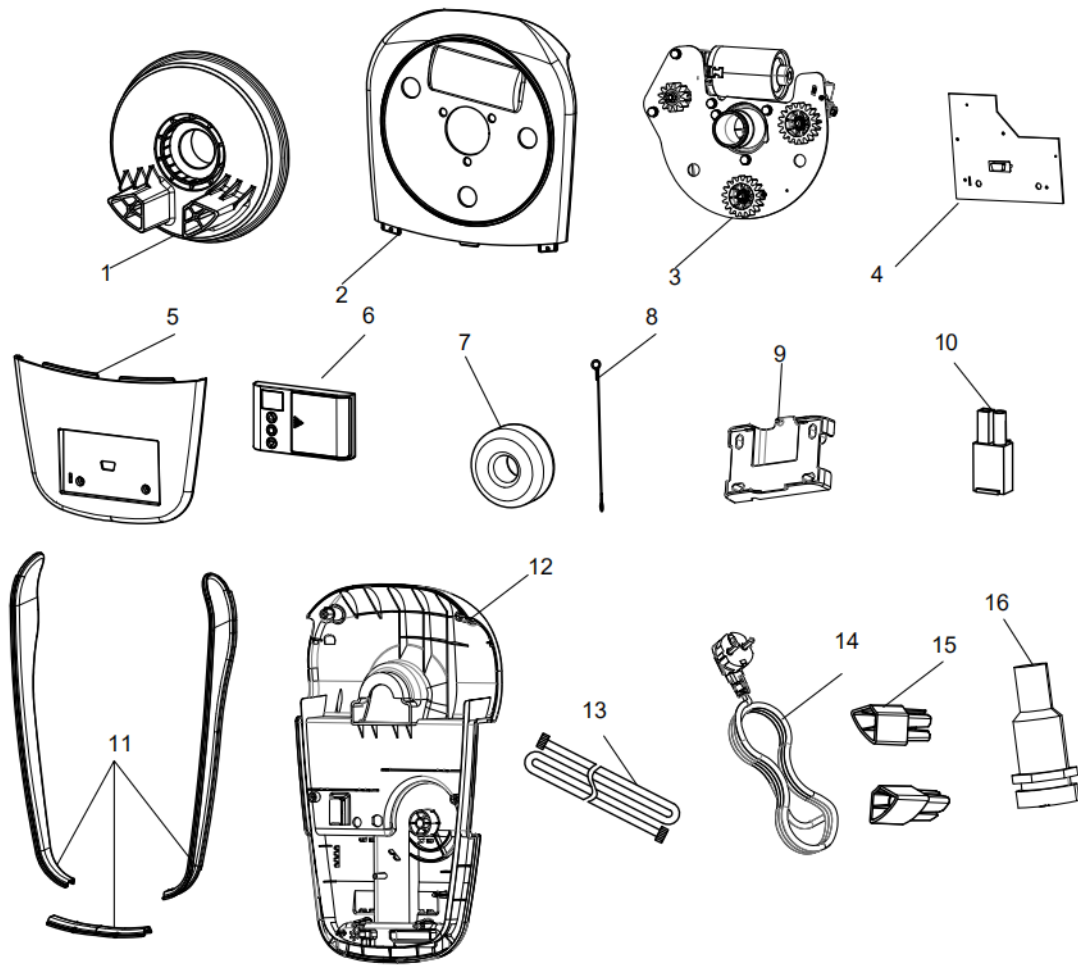

Installation Instruction and User Guide

21.MAINTENANCE

Daily maintenance:

1. No particular maintenance is required for the logic circuit board.
2. Check the door at least twice a year if it is properly balanced, and all working parts are in good working condition or not.
3. Check the reversing sensitivity at least twice a year, and adjust if it is necessary.
4. Make sure that the safety devices are working effectively.
5. Before installing a Flash light, please make sure the rate is within 5 Watt.

The use of roller door openers under the following conditions can ensure and prolong the service life of openers:

1. Garage door spring balance manual operation to open or close the maximum force does not exceed 20 kg.
2. If the Roller door is stuck or unbalanced, trained and authorized professionals are required to perform repairs in a timely manner, the cost of repairs beyond the warranty time shall be paid by the buyer.
3. Please keep the product invoice as proof of purchase and attach it to this manual, to determine the date of purchase if warranty service may be required

This product is not covered by warranty due to the following reasons:

1. Non-compliance with installation, operation, maintenance and testing of this product.
2. Repair, dismantling, re-installation by non-professionals, or moving the product to another location after installation, etc.
3. Damage caused by using any controller other than ours.
4. Problems related to roll doors or roll door hardware causing product damage.
5. Problems caused by power failure or battery, bulb, fuse, power surge, power shock, fire, flood, rain, water, lightning or storm.

Installation Instruction and User Guide

6. Electrical failure due to water or liquid ingress.
7. Without proper repairs or maintenance.
8. Any unauthorized or non-professional modification of the product.
9. Violent operation or excessive load will affect the service life of the automatic roller door motor and cause damage.