



# INSTALLATION & OWNERS MANUAL



**SOLO, CONDO &  
CONDO AC/DC**



Incorporating the:



**DIGITAL  
BUSINESS  
CARD**

AUSTRALIAN AGENTS: Kode Australia Pty Ltd

## INDEX

INTRODUCTION; RECOMMENDATIONS & LEGAL REQUIREMENTS _____	P3
RECOMMENDED TOOLS _____	P4
GENERAL INFORMATION _____	P5
GENERAL SITE LAYOUT _____	P6
OPERATOR LAYOUT _____	P7
SITE INFORMATION _____	P8
GATE MASS, START UP & RUNNING FORCE _____	P9
REMOVING THE LID _____	P10
MANUAL OVERRIDE _____	P10
PC BOARD LAYOUT _____	P11
ELECTRICAL WIRING (SOLO 500; CONDO) _____	P12
ELECTRICAL WIRING CONDO AC/DC ONLY _____	P13
ANCHORING THE OPERATOR _____	P14
SECURING THE OPERATOR TO THE FOUNDATION PLATE _____	P15
MOUNTING THE MAGNET _____	P15
MOUNTING THE RACK _____	P16
FILLING THE GEARBOX WITH OIL (CONDO & CONDO AC/DC ONLY _____	P17
SETTING THE MOTOR DIRECTION _____	P17
PROGRAMMING THE OPERATOR _____	P17
DIGITAL BUSINESS CARD _____	P18
LCD SCREEN _____	P18 - 19
LED INDICATIONS ON MAIN PC BOARD _____	P20
SETTING PARTY MODE _____	P21
SETTING OVERCURRENT SENSITIVITY _____	P21
CONNECTING AN EXTERNAL STATUS LED _____	P22
WIRING INFRARED SAFETY BEAMS _____	P22
CONNECTING AN EXTERNAL RECEIVER _____	P23
CONNECTING A VEHICLE DETECTOR _____	P24
CONNECTING A SOLAR PANEL _____	P25
DIPSWITCH SETTINGS _____	P26
PROGRAMMING & ERASING REMOTES _____	P27
TECHNICAL SPECIFICATIONS _____	P28
WARRANTY _____	P28
ADVERTORIAL _____	P30 - 31

## INTRODUCTION, RECOMMENDATIONS & LEGAL REQUIREMENTS

Congratulations on your purchase of a D.A.C.E gate operator. D.A.C.E has proven to be a leader in the automation field and strives to manufacture high quality products using the latest technology available. D.A.C.E. is constantly working on upgrading their products to bring you, the customer, a product of the highest quality. Other products manufactured by D.A.C.E. include:-

- Swing gate operators: DuraSwing
- Infra-red safety beams: DuraOptics
- Remotes and receivers : DuraTronic
- Slide gate operators: SOLO 500; CONDO & CONDO AC/DC
- Vehicle detection loop: DuraLoop

It is recommended that an experienced gate installer is used to install your gate operator. If you intend installing this operator yourself please read this manual carefully before any installation begins.

D.A.C.E has taken all reasonable steps to ensure that the gate operator is safe to install and use. However it must be remembered that a gate is a heavy piece of moving equipment and may cause serious damage or injury if the gate strikes an object or person. The gate operator has built in collision sensing electronics. Having struck an object the gate will stop and reopen, however this does mean that the gate will physically strike the object before it stops. It is therefore strongly recommended that **DuraOptics** infrared safety beams are installed to reduce the risk of the gate striking an object.

*Note:* The installation of beams does not guarantee against the gate striking an object in its path.

### ***Ensure the following items are checked before any installation is done:***

- The rail is level – the gate must not move on its own at any stage.
- The wheels are turning freely and are not jammed.
- The gate is not bent or bowed in any way.
- The rail has sufficient end stops so that the gate can never run off the end of the rail.
- The portal is constructed in such a way that the gate can not fall over.
- The rollers are turning freely and are not jammed.
- The anti lift device is sufficient in order to stop the gate from being lifted off the rail.
- The gate mass or start-up force does not exceed the maximum as stated in the specifications.
- The gate does not jam in the catch bracket when closing or opening.
- Extreme care should be taken when automating a gate that is constructed out of any solid type of material such as wood, as wind resistance can cause over current problems.
- The gate must not exceed the maximum number of operations stated in the specifications.

*If any of the above points are not satisfactory do not install the operator until all the points are rectified. Remember that if a gate causes damage or injury due to faulty installation then the installer of the equipment will be held liable.*

- It is recommended that your local E.C.A. (Electrical Contractors Association) is contacted in order to obtain the legal wiring regulations pertaining to the area.
- Electrical Shock may occur while installing this equipment.
- Injury or death by electrocution may lead to law suits against the installer/homeowner.
- If you intend to run 230V/AC directly from the Mains supply (house supply) to the transformer, the wiring should be done by a qualified/registered electrician. This is a legal requirement and failure to do so may lead to non-compliance of property or law suits against the property owner in the event of an accident.

## INTRODUCTION, RECOMMENDATIONS & LEGAL REQUIREMENTS cont.

- It is a legal requirement to run all cabling in conduit. The power supply must be run in a separate conduit to ANY other cables.
- Mains supply may only be run in a guarded cable. Under no circumstances may 230V/AC be run using Communication cable, Ripcord or Cabtyre.
- Ensure that all electrical power is switched off before any electrical connections are made.
- Do not open, tamper or modify any of the electrical components of this equipment in any way.
- Do not attempt to repair the equipment, this should only be done by a qualified D.A.C.E. technician.
- D.A.C.E will not be held liable for any accident / incident resulting in damage, injury or death ensuing from the installation of the automatic gate operator.
- Although these operators have built-in collision sensing, substantial damage may still occur. For this reason DuraOptics safety beams should be used on all installations.
- Do not allow children to play near or with any gate, gate operator or remote control.
- It is the responsibility of the installer to ensure that the gate is in good working condition before automating the gate.
- D.A.C.E cannot be held responsible for any gates bumping the ends stops when a gate on a slope is automated.
- It must be noted that an automatic gate is a heavy piece of equipment and injury, even death, may occur due to incorrect installation or operation of the equipment. There are a number of areas that may cause entrapment which could lead to injury.
- Do not operate the gate unless within direct sight.

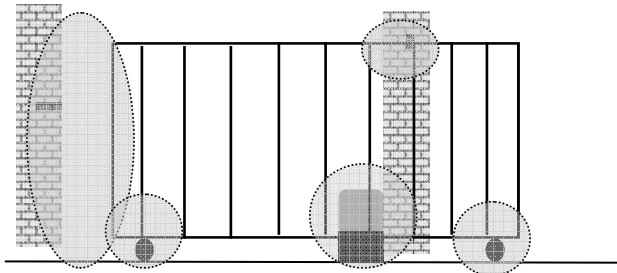

Shaded areas show the possible entrapment areas of an automated gate.

## RECOMMENDED TOOLS

- |                              |                              |
|------------------------------|------------------------------|
| • Drilling machine           | • Steel & masonry drill bits |
| • 8mm / 13mm / 17mm Spanners | • Assorted screwdrivers      |
| • 13 / 17mm Socket           | • Spirit level               |
| • Spade                      | • Pick                       |
| • Multimeter                 | • Tape measure               |
| • Wire cutters               | • Angle grinder              |
| • Hacksaw                    | • Hammer                     |

## GENERAL INFORMATION

- **Auto-close:** allows the gate to close automatically after a selected period of time. If Auto-close is selected, **DuraOptics** Infrared Safety Beams should be fitted.
- **Multi-user mode:** used in town house situation, allows the gate to open and will not accept any other trigger while opening, thus preventing accidental closure on a vehicle/person.
- **Pedestrian access:** allows only partial opening of the gate and will auto-close after 6 seconds.
- **Anti-lift device:** stops the gate being lifted off the rail.
- **Battery:** the battery is used to drive the operator. (*The CONDO AC/DC operator can operate without a battery*). The mains power supply is used to charge the battery only. In the case of a mains power failure, the battery will continue to operate the operator until it runs flat. This should be for  $\pm$  two days under normal conditions. The LCD will show "**MAINS FAIL**" if the mains power has failed and "**LOW BATT**" if the battery is going flat.
- **Battery Back-up:** the **CONDO AC/DC** uses mains power to drive the operator, and the battery is used in the case of mains power failure.
- **Safety Beams:** These reduce the risk of the gate closing on a vehicle. **DuraOptics** (DOPT01) beams should always be used when auto-close is selected.
- **Transformer:** the transformer reduces the 230V mains power to 16 VAC.
- **Charger module:** the on-board charger receives 16 VAC from the transformer and then delivers a trickle charge to maintain  $\pm$  13.4 VDC charge to the battery.
- **Main PC board:** this is the printed circuit board that contains all the electronic components that operate the operator.
- **Remote/Transmitter:** this is usually a hand held device which transmits a radio signal to the receiver to trigger the gate (**DuraTronic** TM002, TM003, TM004, TM006)
- **Receiver:** the receiver triggers the operator after receiving a radio signal from the transmitter.
- **Test button:** this is a button on the main PC Board that can be used to activate the operator. This is usually used during the programming of the operator.
- **Rack:** this is a length of toothed gear mounted on the gate.
- **Pinion gear:** this is the gear on the operator that meshes with the rack gear on the gate to move the gate.
- **Foundation plate:** this is the steel plate that is mounted to a concrete plinth in the ground. The operator is mounted onto the foundation plate using the three mounting bolts.
- **Thumbwheel:** this allows the operator to be put into Manual Override mode so that the gate can be pushed open/closed by hand.
- **Free exit vehicle loop detector:** this allows the gate to automatically open when a vehicle drives over a loop in the driveway.
- **B.A.C. mode:** "Beams Auto Close". This allows the gate to close as soon as a vehicle passes through the Infrared Safety Beams. This prevents the gate going to the fully open position unnecessarily and remaining open awaiting the Auto-Close function to close the gate.
- **Theft deterrent bracket:** Deters the tampering or theft of an operator.
- **Collision sensing/over current:** When the gate is moving and it strikes an object, the software will sense the obstruction due to the higher current draw, this will prompt the operator to stop. If the over current is detected while the gate is closing, then the gate will stop and reopen at slow speed. If the over current is detected while the gate is opening, the gate will stop and remain still. The gate will close on the next trigger that it receives or after the auto-close time has expired. It should be noted that D.A.C.E. recommends the use of **DuraOptics** safety beams on all installations to minimise the chance of the gate closing while there is an object in its path.

## GENERAL INFORMATION cont.

- **End stop:** a physical stopper preventing the gate from running off the end of the rail and causing injury or damage.
- **Intercom:** equipment that allows communication between the gate and the house.
- **LCD Screen:** indicates information regarding the operator status.
- **Manual override:** allows the gate to be moved manually.
- **Party-mode:** allows the gate to remain open even when auto-close is selected.
- **Positive close:** This means that the gate will close up against the end stop / gate post leaving no gap between the gate and the stop. This ensures that any potential electrical contacts of an electric fence make a solid connection when the gate is closed.

## GENERAL SITE LAYOUT

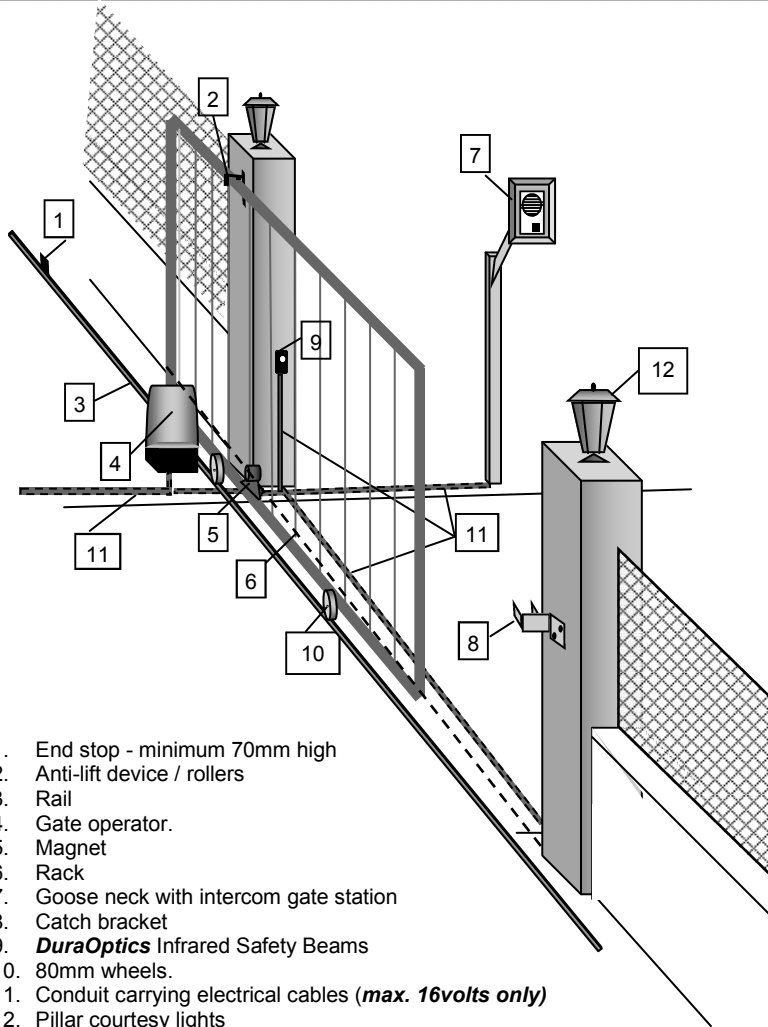

## OPERATOR LAYOUT

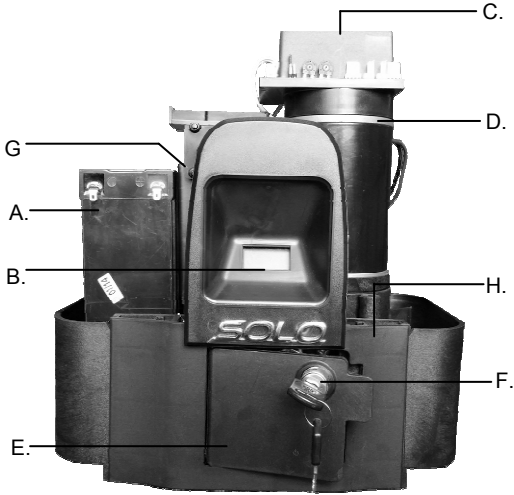

- |    |                                       |
|----|---------------------------------------|
| A. | 12V 7AH Battery                       |
| B. | LCD Screen                            |
| C. | Main PC Board                         |
| D. | 12V DC Electric Motor                 |
| E. | Manual override access door with lock |
| F. | Override access key                   |
| G. | Transformer                           |
| H. | Cable risers                          |

**SOLO/CONDO  
OPERATOR**

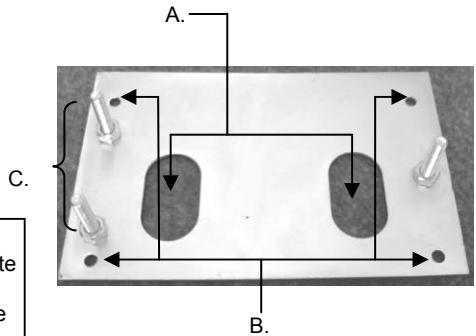

- |    |  |
|----|--|
| A. | Conduit entry holes.   |
| B. | 4 Holes for bolting the plate to the concrete plinth.                        |
| C. | Jacking bolts to secure the operator to the plate and for height adjustment. |

**SOLO/CONDO  
FOUNDATION  
PLATE**

## SITE INFORMATION

The site should be evaluated before the installation begins. The following items should be checked.

- The operator should be installed above flood level to avoid any water damage to the operator.
- To avoid the operator from malfunctioning the rail should be level and above ground level. This will help to keep debris out of the path of the wheels. Any debris lying on the rail may cause the gate to jam or the PC Board to blow a fuse.

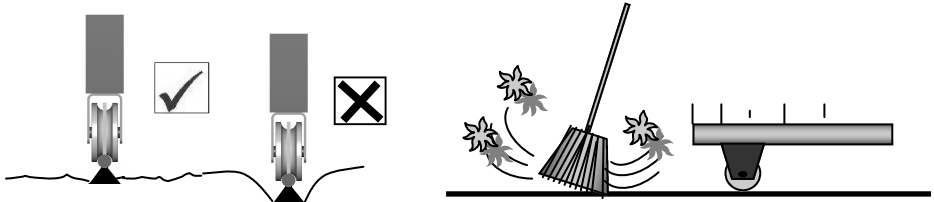

- The gate must not move on its own when left in any position along the rail, if this does occur, the rail must be leveled before the gate is automated.

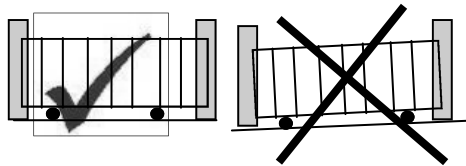

- Keep all trees, branches, bushes and other growth clear of the gate. Failure to do this may lead to the gate jamming.



It is extremely important to evaluate the gate that is to be automated before any automation is done. The following points must be checked. All of the points mentioned below are common causes of gate problems if not checked.

Ensure that the end stops are secure.  
Min. height 70mm.

Recommended 80mm dia. wheels.

It is recommended that 16mm round bar is used to assist with the smooth operation of the gate.

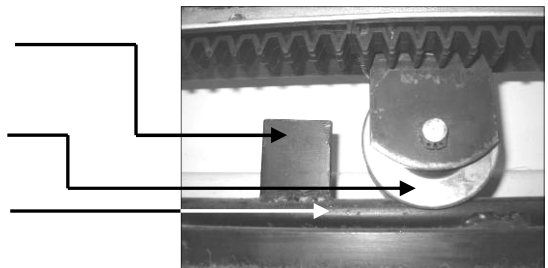



Rollers must roll freely.  
The roller mounting bracket can be used as an anti-lift device.

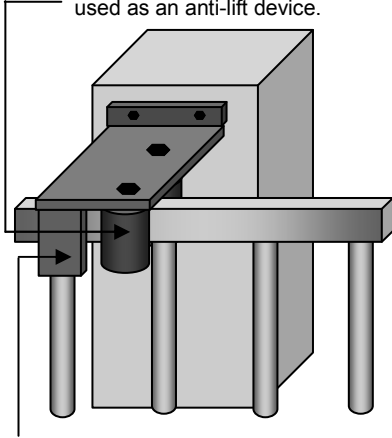

The catch bracket must be used as an anti-lift device.

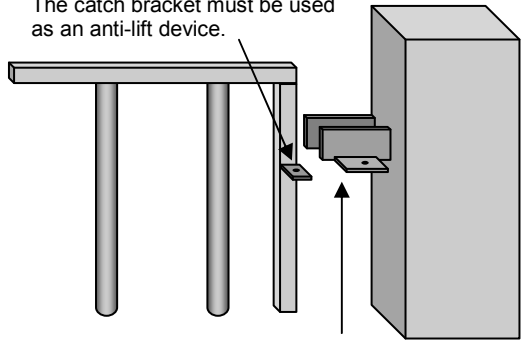

The gate must not jam in the *catch bracket* when opening or closing as this may cause the operator to over current or the fuse to blow.

All precautions must be taken to ensure that the gate cannot run free of the rollers. A device can be fabricated and fitted to prevent this

### MAX. GATE MASS, START UP FORCE & RUNNING FORCE

It is important to check the start up force of the gate before the operator is installed. Place the gate in the fully closed position. Using a fishing scale, pull the gate open and check the kilogram force required to start the gate rolling. This is the start-up force.

At no stage while moving the gate must the reading exceed the force shown in the table below.

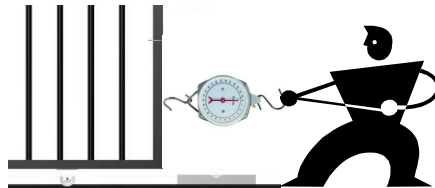

***The D.A.C.E warranty will be void if the gate mass, start up force or running force exceeds the specifications as per the table below***

<u>OPERATOR</u>	<u>MAX. GATE MASS</u>	<u>MAX. START UP FORCE</u>	<u>MAX. RUNNING FORCE</u>
SOLO 500	500kg	18kgF	12kgF
CONDO	600kg	28kgF	18kgF
CONDO AC/DC	600kg	28kgF	18kgF

## REMOVING THE LID

### SOLO/CONDO OPERATORS

**STEP 1**  
Open the access door

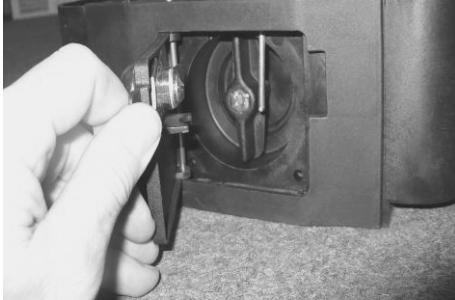

**STEP 2**  
Pull out the pin (the pin will move about 5 mm).  
The lid can now be removed



## PLACING THE OPERATOR IN MANUAL OVERRIDE

**Step 1:** Unlock and open the access door (as in step 1 above).

**Step 2:** To prevent the gate from knocking the end stoppers after reactivating the gate later, be sure to take note of the current position of the gate before proceeding to step 3.

**Step 3:** Turn the thumbwheel clockwise until the gate is free to move.

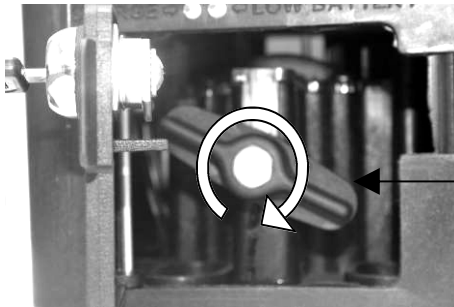

Thumbwheel

**Step 4:** Before putting the gate back into operational mode, place the gate back in the position it was in step 2.

**Step 5:** Turn the thumbwheel anti-clockwise to re-engage the operator. Move the gate until you hear a click.

**Step 6:** The gate must always be operated at least three times after it has been placed back into operational mode. This is called Calibration Mode as it recalibrates the gates end stoppers.

## PC BOARD LAYOUT

The PC Board is a sensitive piece of electronic equipment and should be handled with care.

- Never connect or remove wires on a PC Board while there is power on the board as this may lead to damage.
- Never touch the board with any metal object.
- Never allow the board to get water on it as this may lead to short circuiting and corrosion and will lead to the board malfunctioning.
- No insecticide or other sprays should be used on a PC Board.
- Do not attempt to repair the PC Board. Any repairs must be carried out by an authorized agent.
- Do not apply 230volts to the board (16 VAC and 12 VDC only).
- Never reverse the polarity of the battery wires as this will lead to extensive damage.

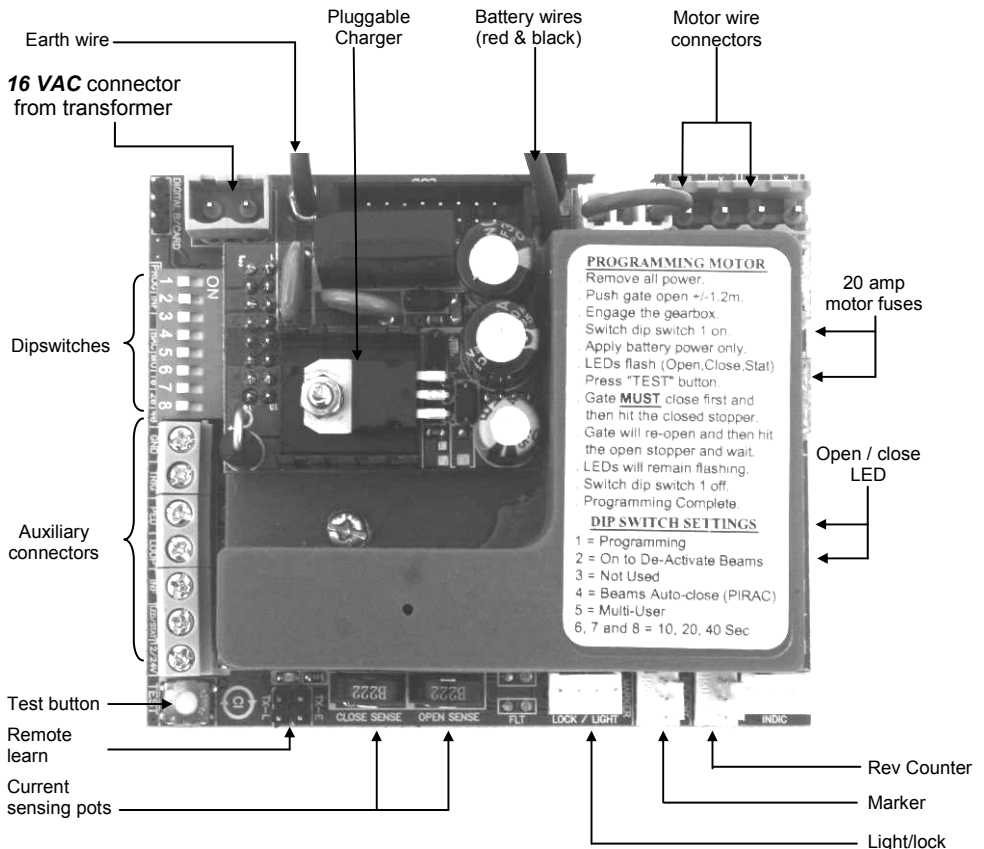

The charger circuit on the PC Board has a rectifier which converts AC voltage to DC voltage, this will generate some heat on the rectifier heat sink. Care should be taken that no wires touch the heat sink as this may cause the plastic insulation of the wire to melt and may lead to a short circuit.

## ELECTRICAL WIRING (SOLO & CONDO OPERATORS ONLY)

- Ensure that ALL power is switched off or isolated before any connections are made.
- The transformer must be plugged into a normal plug socket in the house. 16 VAC is then run directly to the PC board 16V AC connection (does not apply to CONDO AC/DC).
- Do not open or tamper with the transformer as this may cause electrical shock (this will also void any warranty).
- The Earth wire on the PC Board must be connected from the E on the transformer. Alternatively the Earth wire must be connected to an earth spike buried in the ground.
- The cable should be run in a 500mm deep trench in a water proof conduit and must be terminated inside the operator.
- The conduit should have no sharp bends in it as this may cause problems in the future if the cable needs to be pulled out and replaced.
- There must be no joins in the cable underground.
- The cable should be a three core 1.5mm cable.
- Do not use Communication cable as this will void any warranty and is illegal.
- Do not run 230V in the same conduit a 16 VAC.

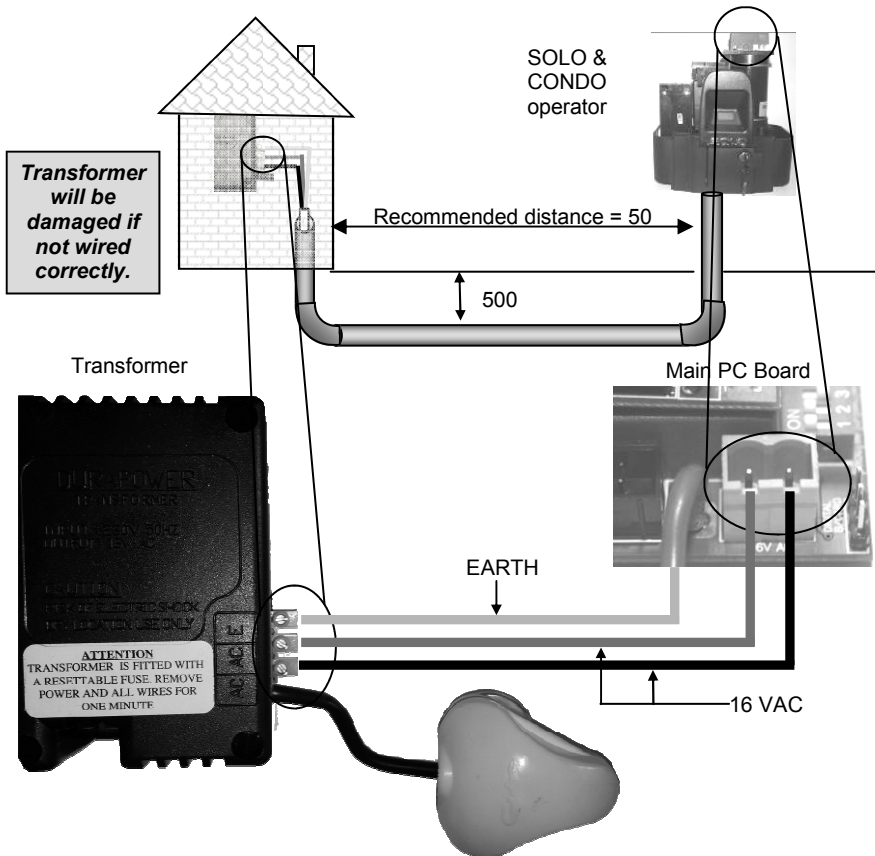

## ELECTRICAL WIRING. (CONDO AC/DC ONLY)

The AC/DC operator has a switcher unit that changes from mains power supply to battery back up supply if the mains power fails. The battery will continue to operate the operator and will switch back to mains power when the mains power returns.

The following section explains the wiring for the CONDO AC/DC operator. This operator is designed to be used in installations where the traffic volume is higher than normal. Caution must be taken when wiring the operator as it requires 230V running to the operator. Wiring this operator must be done in accordance with the local E.C.A. regulations. The wiring should be done by a registered electrician. Extreme caution must be used when wiring the 230V as electrical shock can occur.

**Note! Do not run other cables in the same conduit as the 230V cable.**

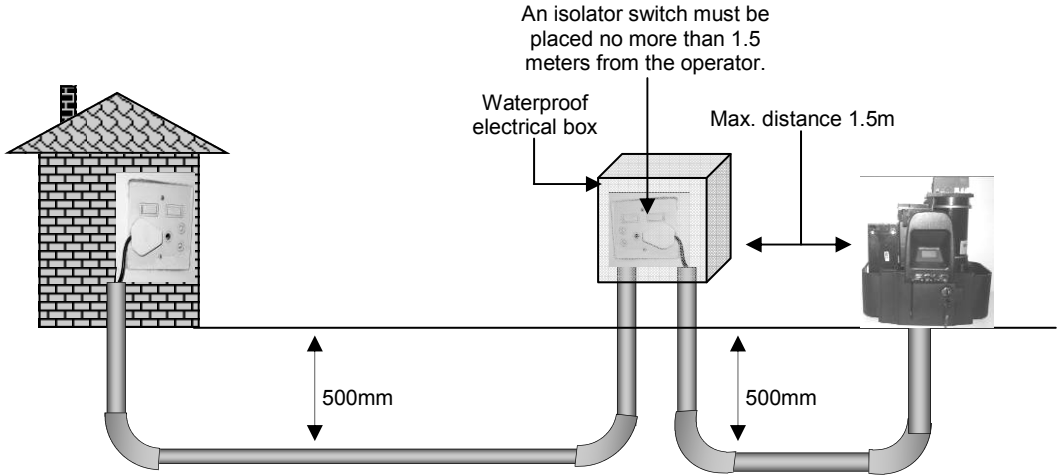

### WIRING THE AC/DC SWITCHER UNIT

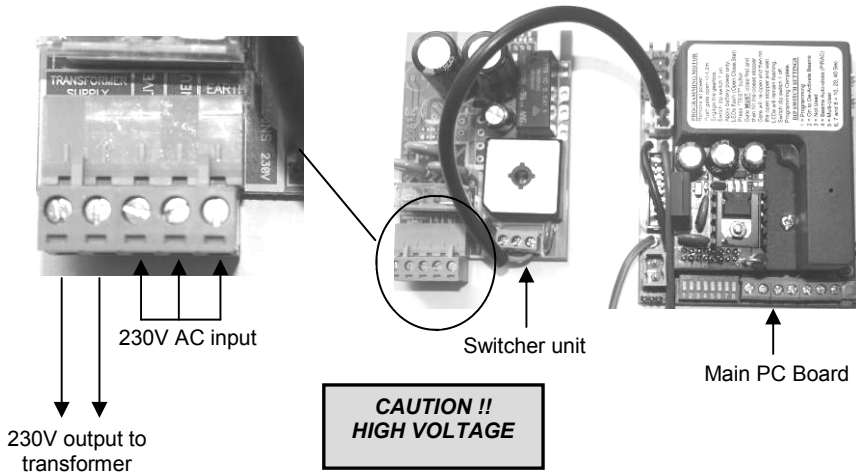

## ANCHORING THE OPERATOR

It is very important that the operator is mounted on a firm foundation that can not move or become loose over time. The foundation should be constructed from concrete. The size of the plinth should be about 300 by 300 mm square and about 200mm deep. The foundation plate supplied with the operator must be securely mounted to the concrete using coach screws and plugs. The foundation plate can also be welded to the gate rail if need be. The concrete should be allowed sufficient time to set before the operator is mounted onto the plate.

**GATE CLOSING TO THE RIGHT**

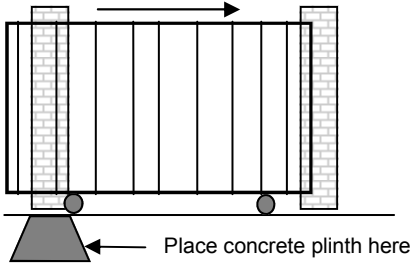

**GATE CLOSING TO THE LEFT**

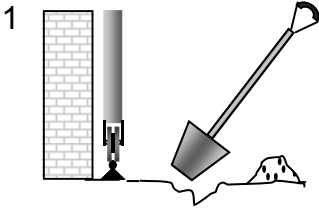
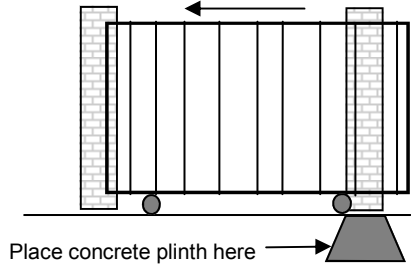

Dig a hole about 300mm

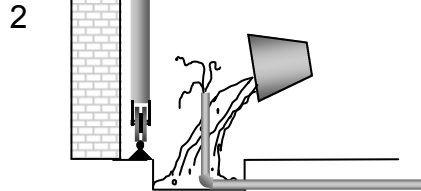

Place the conduit in the correct position before filling the hole with concrete. Flexible conduit may also be used.

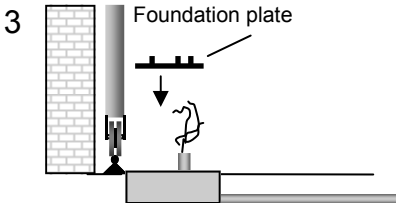

Allow concrete to set and then place the foundation plate onto the concrete plinth

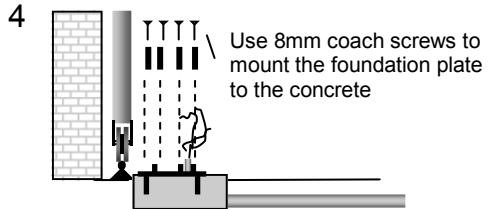

Trim the conduit and the cable to the correct length before placing the operator onto the foundation plate.

**Top view**

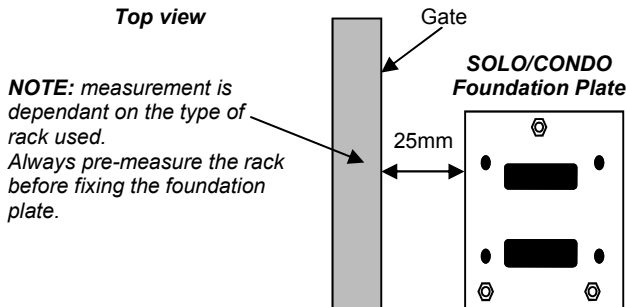

## SECURING THE OPERATOR TO THE FOUNDATION PLATE

When anchoring the operator, it is important to ensure that the following points are checked:

- The electrical cable is in place.
- The concrete is fully set.
- The operator foundation mountings are secure and can not move or become loose.
- The operator should be set level and parallel to the gate.
- The operator must be set above the flood level or if this is not possible, a flood proof wall should be constructed around the operator.

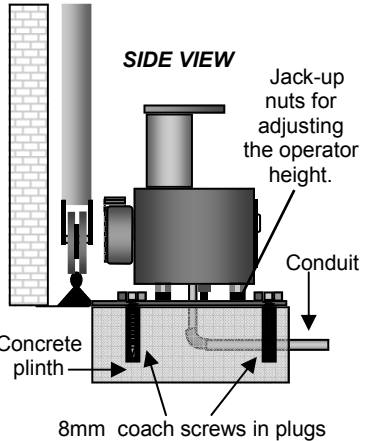
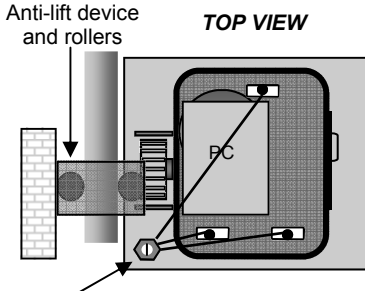

After placing the operator onto the three jack-up bolts, place the three clamping nuts and washers over the bolts to clamp the operator in place.

## MOUNTING THE MAGNET

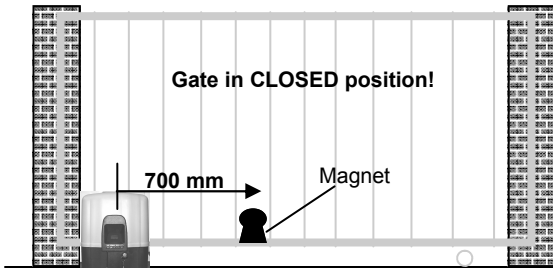

Measure 700mm from the centre of the pinion gear towards the closed end of the gate. If it is not possible to mount the magnet at 700mm, this distance may be increased slightly. **DO NOT invert the magnet.** If the magnet is moved for any reason after the operator has been programmed, then the motor will have to be re-programmed.

Maximum gap between the magnet and the motor cover of **3 mm**.

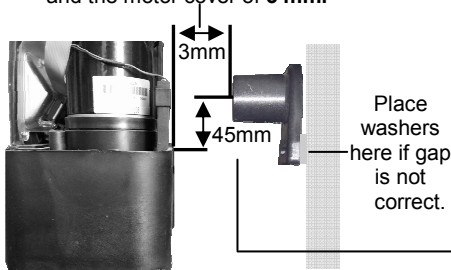

The gap between the operator cover and the magnet, when the magnet passes the motor, must not exceed **3mm**. To check this, manually move the gate until the magnet is directly over the pinion gear then measure between the magnet and the motor lid. If the gap is more than 3mm, place washers behind the magnet until the correct gap is achieved

Ensure that the magnet is fixed to the rack 45mm from the edge of the base to the centre of the magnet.

## MOUNTING THE RACK

The rack is attached to the gate by means of self drilling TEK screws. These TEK screws have a built in drill bit at the tip of the screw. The rack meshes with the pinion gear on the operator which then drives the gate.

It is very important that the rack is mounted securely and that the rack meshes with the pinion gear for the full length of the gate. Any section of rack that meshes to too tight or too loose will cause problems with the operation of the gate.

**Step 1:** ensure that the operator is at least **7 mm above the ground level** and that the gate is in the closed position. **Fig A**

**Step 2:** place a piece of the rack on the pinion of the operator, ensuring that the teeth of the rack and the pinion mesh correctly.

**Step 3:** now fasten the rack to the gate using the TEK screws. The TEK screw should be placed in the centre of the slot in the rack so as to allow for adjustment later. **FIG B**

**Step 4:** push the gate towards the open position continuing to secure the rack to the full length of the gate. Ensure that the rack is securely meshed with the pinion at all times during this operation. Repeat step 4 until the full length of rack is attached to the gate.

**Step 5:** using the jack-up bolts under the operator, **drop the operator 2mm**, this allows a slight gap between the teeth of the rack and the pinion so as to prevent any binding or tight spots on the rack.

### FIG C

**Step 6:** push the gate all the way open and closed to check that the rack is meshing with the pinion for the complete length of the gate.

Check that the rack is not touching the operator while running and also check that the rack covers at least three quarters of the pinion at all times when viewed from above.

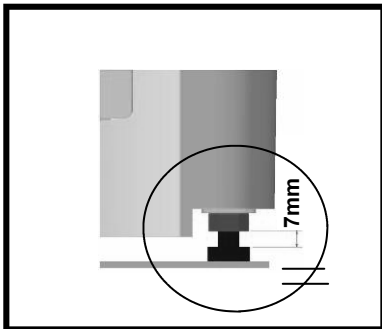

Start with 7 mm space

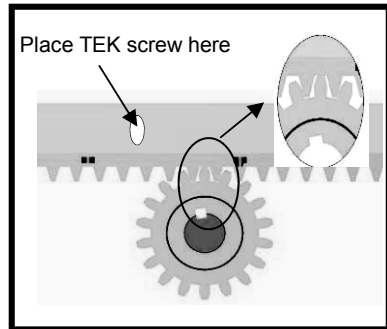

Place the TEK screws as shown below for the complete length of rack.

IT IS RECOMMENDED THAT THE RACK IS MOUNTED AS SHOWN AND NOT INVERTED, AS THIS MAY CAUSE OBSTRUCTION SENSING PROBLEMS.

Drop operator height by 2 mm when rack is secured to gate.

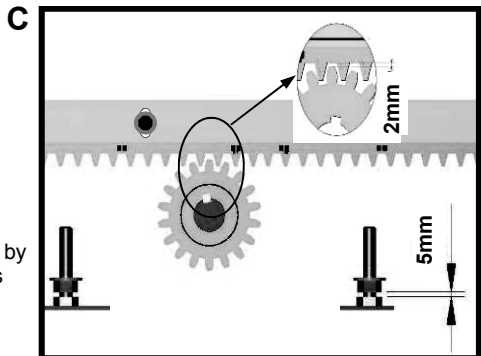



## FILLING THE GEARBOX OIL (CONDO & CONDO AC/DC only)

**VERY IMPORTANT: GEARBOX MUST BE FILLED WITH THE SUPPLIED OIL BEFORE COMMISSIONING THE OPERATOR.**

Fill the gearbox as shown below. The entire bottle (70ml) needs to be emptied into the gearbox.

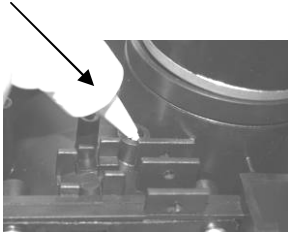

Use S.A.E.75W/90 oil to refill the gearbox

The gearbox oil level needs to be topped up periodically. Remove the oil level screw and add oil until the oil just starts to run out of the hole.

**REPLACE THE SCREW!!!**

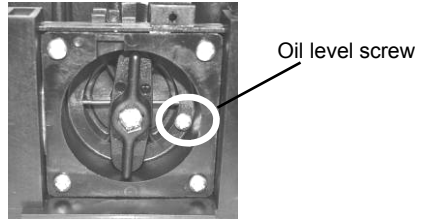

## SETTING THE MOTOR DIRECTION

When programming the operator the gate must always move to the closed position first. If the operator opens first, reverse the motor direction by swapping the motors wires as per below and then reprogram the operator.

Swap the Blue/Black motor wires to change the motor direction.

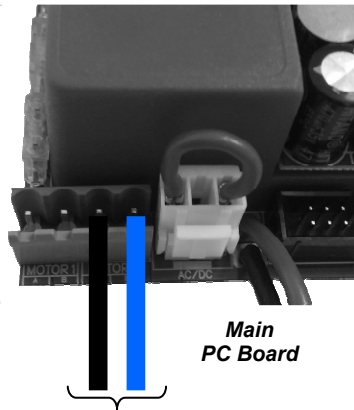

## PROGRAMMING THE OPERATOR

To program the operator follow the steps below.

1. Remove all power from the main PC Board.
2. Manually open the gate 1m -1.5m (this will be the pedestrian opening distance).
3. Engage the gearbox.
4. Switch dipswitch 1 on.
5. Apply battery power only. The Open, Close and Status LEDs will flash rapidly.
6. Press "TEST" button.
7. The gate **MUST** drive to the CLOSED end stopper and then drive to the OPEN end stopper (the LEDs will remain flashing).

*Continued on pg. 18*

## PROGRAMMING THE OPERATOR cont.

8. Switch dipswitch 1 off.  
Programming is now complete.

In step 5, the gate must close first. If the gate opens first, then the motor wires must be reversed. This will change the operator direction. (See Setting the motor direction)  
Do not connect any other auxiliary wires to the PC Board until the operator is fully programmed.

- **Do not allow the infrared beams to be interrupted during the programming procedure.**
- **Before pressing the Test Button in step 6, ensure the gate is clear of any obstacles.**
- **Remove all power before connecting auxiliary equipment.**

## DIGITAL BUSINESS CARD (D.B.C)

The Digital Business Card (D.B.C) enables the installer to load his company details onto the operator LCD. These details will constantly display on the LCD so that the installer can be called when technical assistance is required or a service is due.

For the installer to load his company details the following steps must be followed:

**Step 1:** Acquire a D.B.C.

**Step 2:** Installer details to be loaded onto D.B.C by dealer, merchant or agent of D.A.C.E products.

**Step 3:** Keep D.B.C at all times for future installations.

**Step 4:** When installation is complete remove all power from the operator (this includes mains power).

**Step 5:** Insert D.B.C on pins labelled DIGITAL B/CARD.

**Step 6:** Apply power to main PC Board.

**Step 7:** Remove D.B.C.



Step 5: Insert  
D.B.C into pins  
labelled DIGITAL  
B/CARD

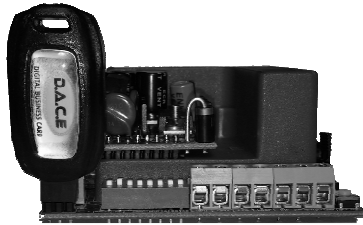

Step 6: Apply  
power



Step 7: Remove  
D.B.C

## LCD SCREEN

The LCD is an easy to use screen that gives the owner / installer information regarding programming and operator status. Whenever the operator is programmed or a fault occurs, refer to the screen for diagnostic assistance. In certain cases the screen will give a message that reads "Call Technician" this means that the operator needs to be checked by an installer. The messages on the screen are generally self explanatory. However the following table gives a description of the messages and their meaning.

*Continued on pg. 19*

## LCD SCREEN cont.

Some of the messages below have been shortened to show the main message. Certain messages will also show the action needed.

**LCD Screen**



<b>MESSAGE</b>	<b>MEANING / ACTION</b>
LOW BATTERY	THIS MESSAGE WILL SHOW AFTER INITIAL START UP, IF THE LOW BATTERY MESSAGE REMAINS AFTER THE OPERATOR IS TRIGGERED,CHECK BATTERY VOLTAGE / CHECK CHARGER VOLTAGE
MAINS FAIL	CHECK THE MAINS POWER / CHECK TRANSFORMER / CHECK CHARGER.
GATE CLOSED	THE GATE IS IN THE CLOSED POSITION.
GATE OPEN	THE GATE IS IN THE OPEN POSITION.
OBSTRUCTION	THE GATE HAS SENSED AN OBSTRUCTION. CHECK THE WHEELS / ROLLERS/ RACK/ BRACKETS/ FUSES/ FORCE SETTING POTS.
NO REV PULSES	FAULTY REV COUNTER, PC BOARD MOUNTING MAY BE LOOSE, REV COUNTER MAGNET HOLDER IS BROKEN.
AUTO-CLOSE ACTIVE	THE GATE IS SET TO AUTO CLOSE.
PARTY MODE	THE GATE IS IN AUTO-CLOSE OVERRIDE .
PROGRAM MODE	THE GATE IS IN PROGRAM MODE.
BEAMS BLOCKED	THE INFRARED SAFETY BEAMS ARE BLOCKED / FAULTY/ THE BEAMS DIPSWITCH IS OFF.
PROGRAMMING CLOSE POSTION	THE GATE IS CLOSING WHILE PROGRAMMING.
BEAMS AC MODE	THE BEAMS AUTO CLOSE MODE IS ACTIVE
PROGRAMMING OPEN POSITION	THE GATE IS OPENING WHILE PROGRAMMING.
PROGRAMMING COMPLETE PUT SWITCH 1 OFF	THE PROGRAM IS COMPLETE.
MARKER OK	INDICATES WHEN THE MAGNET ON THE GATE IS SENSED BY THE MARKER.
SERVICE DUE	THE OPERATOR REQUIRES A SERVICE.

## LED INDICATIONS ON MAIN PC BOARD

### STATUS LED

- ON:** gate open or in motion.
- OFF :** mains power off
- FLASHING:** this LED will flash once every 2 seconds when the gate is closed and the mains power is on.

### OPEN LED

- ON:** gate open.

### CLOSED LED

- ON:** gate closed.

### 12V LED

- ON:** 12V output fuse ok.
- OFF:** 12V output fault.

### INF LED

- ON:** infrared beams circuit is ok.
- OFF:** beams obstructed or faulty

### TRIG LED

This LED should be **off** at all times and will flash when receiving a trigger.

- ON:** permanent on indicates trigger fault
- OFF:** normal

### PED LED

This LED should be **off** at all times and will flash when receiving a pedestrian trigger.

- ON:** permanent on indicates pedestrian trigger fault
- OFF:** normal

### LOOP LED

- ON:** vehicle parked on ground loop
- OFF:** normal

### REV

This LED will flash when receiving a pulse from the rev counter when gate is in motion. If the LED does not flash when in motion this will indicate a faulty rev counter.

### LOW BATT

This LED will flash indicating a low battery.

### LED LAYOUT

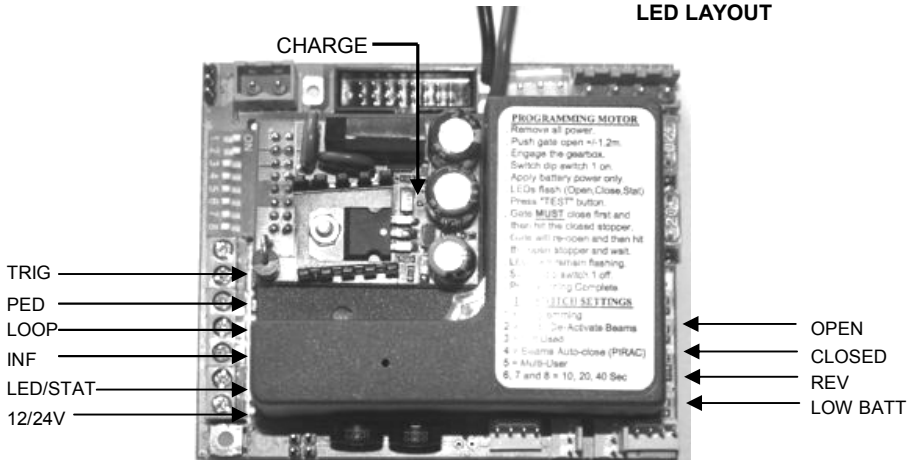

## SETTING PARTY MODE (AUTO-CLOSE OVERRIDE)

This function is normally used when the gate is required to stay open but Auto-close function is active.

- To set the party mode, push and hold the gate's trigger button until the gate starts to open. Release the trigger. The gate will now stay open until it is reset into normal operating mode.
- To reset the gate into normal operating mode, push the gate's trigger button twice within three seconds. The gate will now operate as normal.

## SETTING OVERCURRENT SENSITIVITY

The PC Board is designed to detect overcurrents. This means that if the gate hits an object or is obstructed it will see an increase in the electrical current and the gates will stop driving. The results of the detected overcurrent will be different depending on what the gate is doing at the time of the overcurrent.

- If the gate is closing and an overcurrent is detected the gate will stop and then re-open.
- If the gate is opening and an overcurrent is detected, the gate will stop and will not move until it receives another trigger; the auto-close time is reached or the obstruction has been removed.

### **Setting the overcurrent sensitivity:**

The sensitivity can be adjusted dependent on gate's requirements. It must be noted that if the sensitivity is set too low, the gate will drive harder when an obstruction is encountered increasing the risk of injury or damage to a vehicle/object. Before adjusting the sensitivity check that the gate is operating correctly i.e. dirt, branches or garden growth hindering operation etc.

There are two pots found on the PC Board. One pot is to set the open sensitivity and the other is to set the close sensitivity.

- To decrease sensitivity (usually because a heavier gate is being automated or due to wear and tear over time) use a small flathead screwdriver and turn the pot clockwise. The adjustment should be done in very small increments, until the desired sensitivity is achieved. Use **extreme caution** when setting the pots as this can cause severe injury or damage if the sensitivity is set too low.
- To increase sensitivity (usually because a very light gate is being automated) turn the pot anti-clockwise. Take care not to set the pot too sensitive as this may cause the gate to overcurrent too easily due to other external forces such as wind, small pebbles, leaves, sand etc.

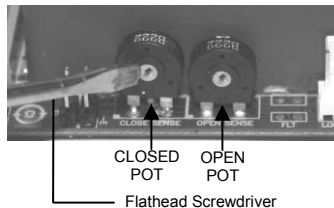

## CONNECTING AN EXTERNAL STATUS LED

An external status LED can be connected to the main PC Board. This LED will indicate the status of the gate. The LED can be fitted to the intercom or any other convenient place.

### CONNECTOR BLOCK ON MAIN PC BOARD

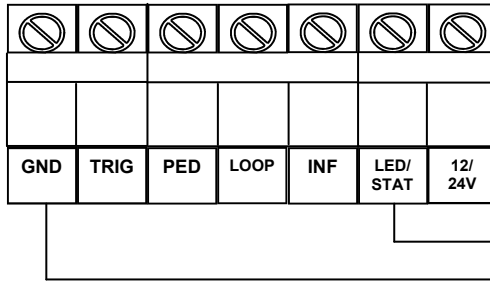

## WIRING INFRARED SAFETY BEAMS (DuraOptics)

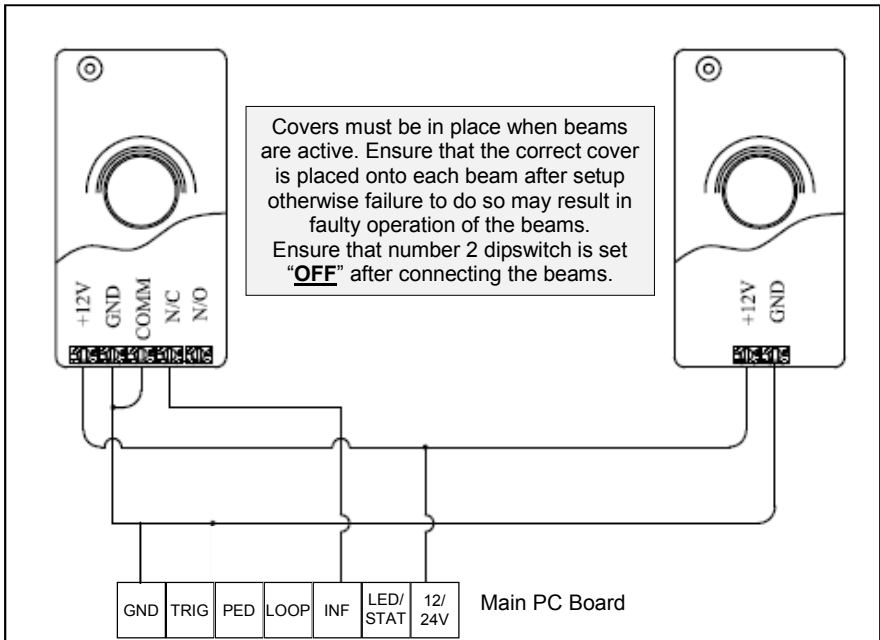

**Note: although the installation of infrared safety beams does reduce the risk of the gate striking an object while closing it does not guarantee against it.**

## CONNECTING AN EXTERNAL RECEIVER

**When connecting any auxiliary equipment to the PC Board ensure that all power is removed from the PC Board.**

A DuraTronic external receiver can be connected to the PC Board. This will be necessary if there are more than 15 remotes to be used or if the range of the on-board receiver is not sufficient. The DuraTronic external receiver can hold 128 remotes. The DuraTronic receiver should be mounted outside the operator housing for increased range.

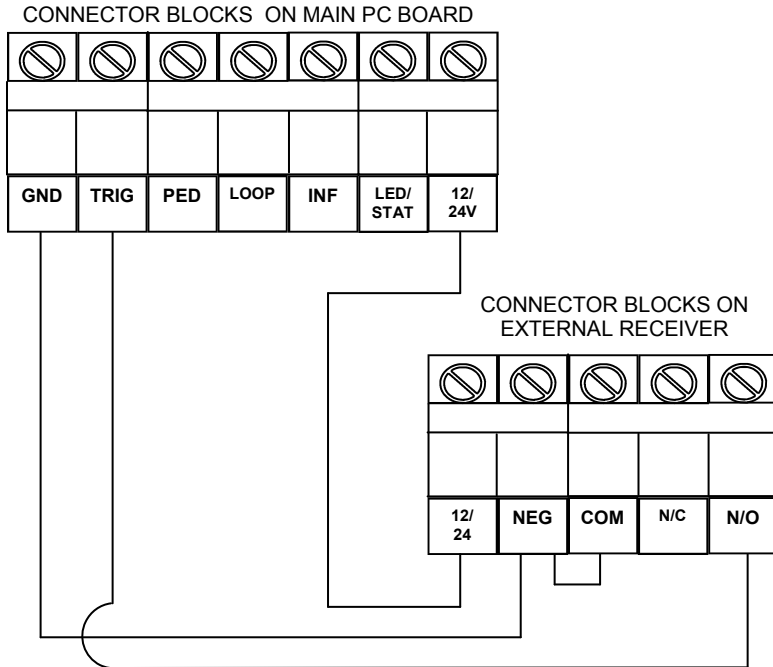

To program remotes to the receiver:

1. Press and hold the button on the remote.
2. Place the jumper over the two TX LEARN pins for 1 second.
3. Remove the jumper.
4. Release the button on the remote.

Repeat the above steps for each remote to be programmed.

**PEDESTRIAN OPERATION:** A separate receiver, keyswitch or keypad must be connected to operate the gate in the pedestrian mode. The connection is done in the same manner as the diagram above with the exception of the TRIG connection. Instead of TRIG to N/O it must be PED on the main PC Board to N/O.

In pedestrian mode the gate will open partially and then close automatically after 6 seconds.

## CONNECTING A VEHICLE DETECTOR

A vehicle detection loop is used to automatically open the gates when a vehicle approaches (most commonly in the exit direction). The following instructions are for a DuraLoop Vehicle Detector. Note that whatever product is used it is important to follow the manufacturers installation instructions as these may differ from one product to another.

It is extremely important that the loop is placed in the driveway far enough from the gate so that the vehicle does not collide with the gate

### Connector block on main PC Board

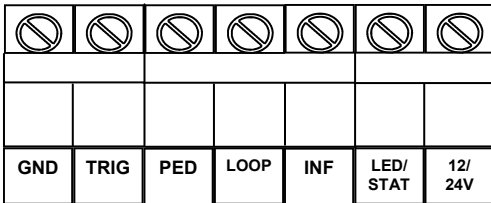

**PLEASE NOTE: LOOP input is used for slide operators ONLY!!**

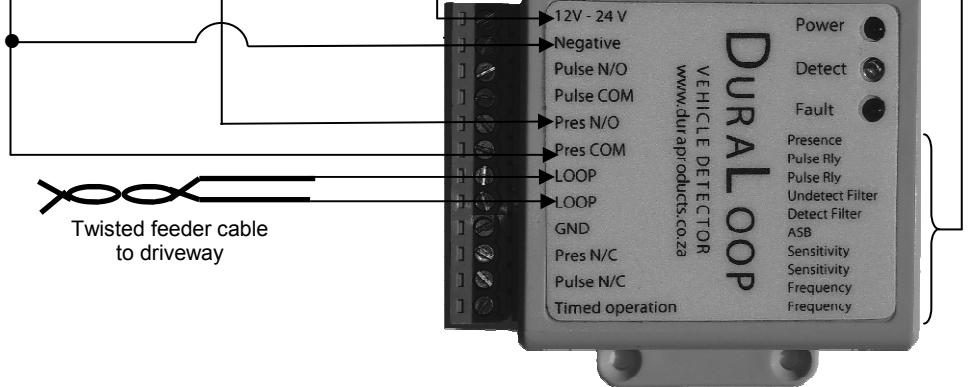



## CONNECTING A SOLAR PANEL

**A REGULATOR IS NOT  
REQUIRED WHEN  
CONNECTING A SOLAR  
PANEL**

**SOLAR PANEL**  
(min 20 Watts)



An external regulator is NOT required when connecting a solar panel. Ensure that the panel does NOT exceed the min and max specifications.

Negative wire  
(-)

Positive wire  
(+)

**Solar Panel Specifications:**

- **Min output voltage 16.5 VDC**
- **Max output voltage 21 VDC**  
(an output voltage below 16.5 VDC will not charge the internal battery).

Connect the solar panel wires to the 16 VAC plug on the main PC Board.  
(Wire polarity is not important)

**16 VAC connector**  
from transformer

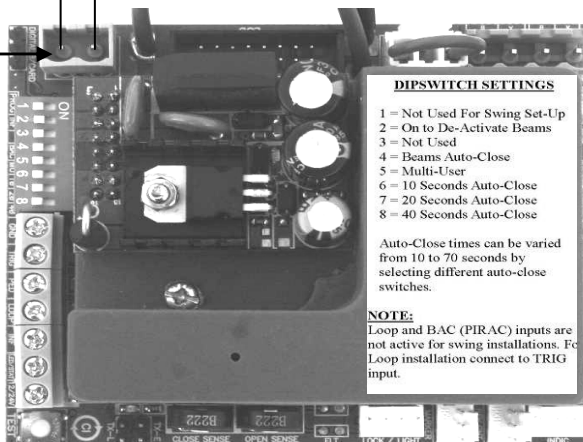

**DIPSWITCH SETTINGS**

- 1 = Not Used For Swing Set-Up
- 2 = On to De-Activate Beams
- 3 = Not Used
- 4 = Beams Auto-Close
- 5 = Multi-User
- 6 = 10 Seconds Auto-Close
- 7 = 20 Seconds Auto-Close
- 8 = 40 Seconds Auto-Close

Auto-Close times can be varied from 10 to 70 seconds by selecting different auto-close switches.

**NOTE:**

Loop and BAC (PIRAC) inputs are not active for swing installations. For Loop installation connect to TRIG input.

## DIPSWITCH SETTINGS

### PROGRAM MODE

Refer to page 17 & 18 for program sequence.

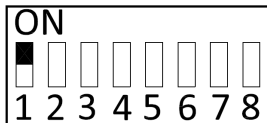

**No. 1:** USED DURING PROGRAMMING SEQUENCE.

### INFRARED SAFETY BEAMS

Number 2 dipswitch is used to activate the safety beams. If no safety beams are used, number 2 dipswitch must be in the **ON** position. If safety beams are connected, number 2 dipswitch must be set to the OFF position. NOTE if number 2 dipswitch is OFF and there are no beams connected, the gate will not close.



**No.2:** ON IF NO BEAMS

### BEAMS AUTO-CLOSE

B.A.C. is not active with swing operators.



**No. 4:** ON TO ACTIVATE BEAMS AUTO-CLOSE.

### AUTO-CLOSE

Auto-close is an option that allows the gate to close automatically after a chosen time delay, this delay can be from 10 to 70 seconds. Auto-close is selected by using the dipswitches on the main PC Board. Dipswitch numbers 6,7 and 8 are the auto-close time select switches. The times are as follows.

**6 off ; 7 off; 8 off = no auto-close**

**6 on; 7 off; 8 off = 10 seconds**

**6 off; 7 on; 8 off = 20 seconds**

**6 off; 7 off; 8 on = 40 seconds**

**6 on; 7 on; 8 on = 70 seconds**

Any combination can be used to select the desired auto-close time.

***It is strongly recommended that DuraOptics safety beams are used when Auto-Close is selected as this reduces the chance of the gate closing on an object and causing injury or damage.***

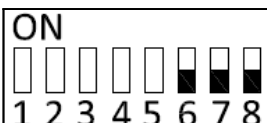

**No's 6; 7 & 8:** SETTING AUTO-CLOSE

## MULTI-USER MODE

To set multi-user mode, place number 5 dipswitch in the ON position.

**NOTE !!! If Multi-user is selected, an auto-close time must also be selected. If an auto-close time is not selected, the gate will immediately close after opening.**

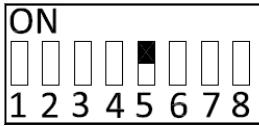

No.5: ON FOR MULTI-USER

## PROGRAMMING THE REMOTES

To program remotes to the on-board receiver complete the following steps. It is recommended that the remotes are numbered in order of programming. This will assist with erasing any lost or stolen remote at a later stage.

**Step 1:** press and hold the button that is to trigger this application on the remote. It is important that this button is continuously held from step 1 through to 3.

**Step 2:** place the jumper over the two pins on the PC Board called **TX- L** for 2 seconds.

**Step 3:** remove the jumper from the two pins.

**Step 4:** release the button on the remote.

That particular button on the remote is now programmed to the receiver.

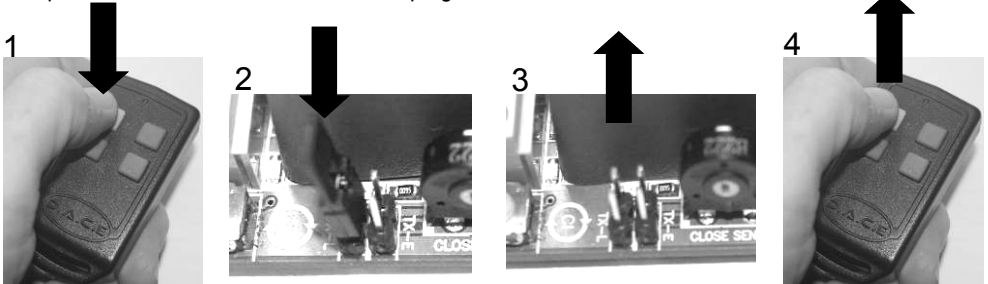

## ERASING ALL REMOTES PROGRAMMED TO THE RECEIVER

**Step1:** place the jumper over the two pins called **TX-E** and count 4 flashes on the yellow LED on the receiver.

**Step2:** remove the jumper.

**Step 3:** replace the jumper and count 2 flashes on the LED.

**Step 4:** remove the jumper.

**Step 5:** replace the jumper and count 4 flashes on the LED

The LED will now flash rapidly for one second to indicate that all remotes have successfully been erased.

**NOTE: The time between the jumper being removed and replaced on the pins must NOT exceed 2 seconds.**

## ERASING A SINGLE REMOTE PROGRAMMED TO THE RECEIVER

If the remotes are not numbered all remotes will need to be erased and reprogrammed once again. If all remotes are numbered it is possible to erase a single remote. The preceding remote is needed to erase the required remote. For example remote number 6 will erase remote number 7 etc.

**Step 1:** place the jumper over the **TX-E** pins.

**Step 2:** press the button of the preceding remote.

**Step 3:** remove the jumper.

The remote will now be erased. The next remote to be programmed will take the place of the erased remote. In this example it will take the place of number 7 and must be numbered as such.

**TECHNICAL SPECIFICATIONS**

	<b>SOLO 500</b>	<b>CONDO</b>	<b>CONDO AC/DC</b>
<b>Application:</b>	Single Dwelling Only	Town House	Town House
<b>Maximum number of openings for a 4m gate: (7Ah battery)</b>			
Pull force 7.2kgF	95	95	1440
Pull force 9.1kgF	70	70	1440
Pull force 13.5kgF	n/a	50	1440
<b>Maximum Gate Mass:</b>			
	500kg	600kg	600kg
<b>Max. Start up force:</b>	18kgF	28kgF	28kgF
<b>Max. Running force:</b>	12kgF	18kgF	18kgF
<b>Maximum Gate Size:</b>	100m	100m	100m
<b>Collision Sensing:</b>	Electronic	Electronic	Electronic
<b>Duty Cycle:</b>	50%	50%	50%
<b>Electric Voltage:</b>	12 Volt	12 Volt	12 Volt
<b>Motor Power:</b>	120 watts	120 watts	120 watts
<b>Supply Voltage at Gate:</b>	16V AC	16V AC	230V AC
<b>On board receiver:</b>	Yes	Yes	Yes
<b>Packaged operator weight (excl. rack &amp; battery):</b>	9.1kg	10.3kg	10.3kg
<b>Packaged operator dimensions (excl. rack &amp; battery):</b>	32(L) x 24(W) x 36(H) cm	32(L) x 24(W) x 36(H) cm	32(L) x 24(W) x 36(H) cm

**24 MONTH WARRANTY**

D.A.C.E. offers a Factory Warranty on this equipment. The following terms and conditions apply to all warranty claims.

- D.A.C.E. warrants the original purchaser, at the point of sale, that the product is in good working order and is free from any defect.
- Any warranty claim must be accompanied by the original invoice.
- The original purchaser is responsible for checking that the equipment is free from any visible defect before it leaves the point of sale.
- The warranty period is 24 months from date of purchase.
- The warranty is a “walk in “ warranty. No warranty claim will be entered into “on site”.

**Continued on pg. 29**

## 24 MONTH WARRANTY cont.

- The equipment must be returned to the factory with the original invoice for any repair or replacement.
- The transport cost is for the end users account.
- If the equipment was purchased at a dealer, merchant or agent of D.A.C.E. the claim must be directed to said merchant, dealer etc.
- The warranty will become void if any of the following apply in any way:
  1. Incorrect installation of the equipment.
  2. Any physical conditions exceed the D.A.C.E specifications.
  3. Incorrect wiring of the equipment.
  4. Any circumstances out of the control of D.A.C.E such as lightning, flooding, power-surges, fire, corrosion & insect infestation.

~ ***NOTE: the transformer is not guaranteed due to power fluctuations.***

~ ***Any warranty claim must be inspected and tested by a D.A.C.E. representative before any further claim is entered into.***

SHOW YOUR HOME THE RESPECT IT DESERVES!

THE ULTIMATE CHOICE

# LAZER

GARAGE DOOR OPERATORS

NEW!  
LASER GUIDED  
PARKING SYSTEM



FOR SECTIONAL, ROLL-UP AND TIP-UP GARAGE DOORS

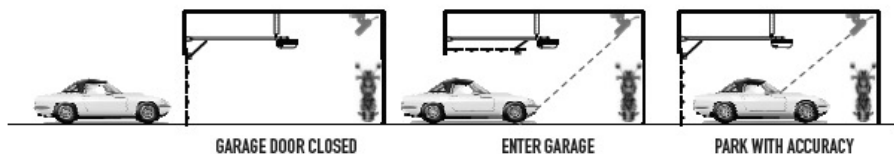

### AN INDUSTRY FIRST!

Avoid dents in your car with the **LAZER** Park Assist facility for precise and safe parking. Mounted on the ceiling it activates when the garage door opens. The laser beam can be focused anywhere on the car providing the driver with exact parking guidance every time.

### INNOVATION THAT SETS NEW STANDARDS:

- 1 THE DIGITAL BUSINESS CARD** This innovative product enables the installer to load his business details onto the LCD screen giving you peace of mind that the details are readily available should the need arise to call a technician. At all times the screen will provide your installers details (if they have been downloaded by the installer) for when back up service or assistance is required. This is also available on our slide motors.
- 2 THE ROLL-ON** This linear roll-up kit on a vertical side mount application, unique to **LAZER**, has four bearings, preventing the drive channel from jamming should the door go out of balance.
- 3 NO LIMIT SWITCHES** A huge advancement in garage motor technology. Limit switches have proven to be problematic and difficult to setup, especially on doors where the motor has to be mounted deep inside the drum of a roll-up door.



## ONCE AGAIN DACE PROVES TO BE A MARKET LEADER

DACE, being the innovators they are, have come up with a World First, the **DIGITAL BUSINESS CARD**

Gone are the days when you gave your client your business card and knew they would either lose it or throw it away. Come they day when your services were urgently required or they wished to refer you to friends, they couldn't remember your company details and were forced to refer to the yellow pages or the internet. Now the job that was rightfully yours has been given to someone else.



That was then! Now you simply get your details loaded onto your Digital Business Card by your supplier. Having completed an installation of a COMPACT 300/500; SOLO; CONDO; CONDO AC/DC or any of the LAZER Garage Door Operators, plug your Digital Business Card into the PC Board and, VOILÀ, in 5 seconds your details are stored safely on the operator's LCD screen, always promoting your company and ensuring repeat business.

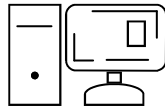
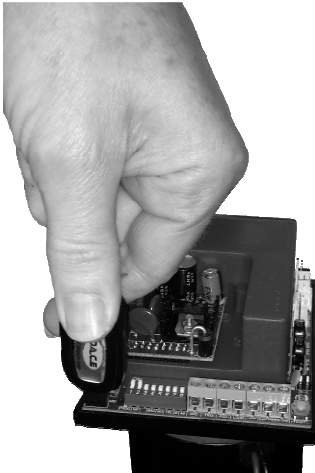

Your supplier will download your details onto the Digital Business Card via their computer using DACE software.

### ***DON'T LOSE YOUR DIGITAL BUSINESS CARD!***

Keep it with you at all times and after each installation of a DACE product (excluding DuraSwing), simply load your details onto the PC Board and let it keep working for you. Never fear, should your details change, merely take your Digital Business Card to your supplier and get your new details loaded over your old ones. A smart and affordable alternative to your old printed business card.



[www.dace.co.za](http://www.dace.co.za) • [info@duraproducts.co.za](mailto:info@duraproducts.co.za)



**PROUD MANUFACTURERS & SUPPLIERS OF:**

SLIDE GATE OPERATORS:

- SOLO
- CONDO
- CONDO AC/DC

SWING GATE OPERATORS:

- DURASWING

GARAGE DOOR OPERATORS:

- LAZER SECTIONAL
- LAZER ROLL UP
- LAZER VERTICAL ROLL UP
- LAZER TIP UP

TRANSMITTER & RECEIVERS:

- DURATRONIC 2; 3; 4 & 6 BUTTON REMOTES
- DURATRONIC On-BOARD & EXTERNAL RECEIVERS

SAFETY BEAMS:

- DURAOPTICS

VEHICLE DETECTION LOOP:

- DURALOOP