

AUTOMATIC TECHNOLOGY AUSTRALIA PTY LTD

axessTM

Pro Series 1300

**COMMERCIAL
OVERHEAD DOOR OPENER**

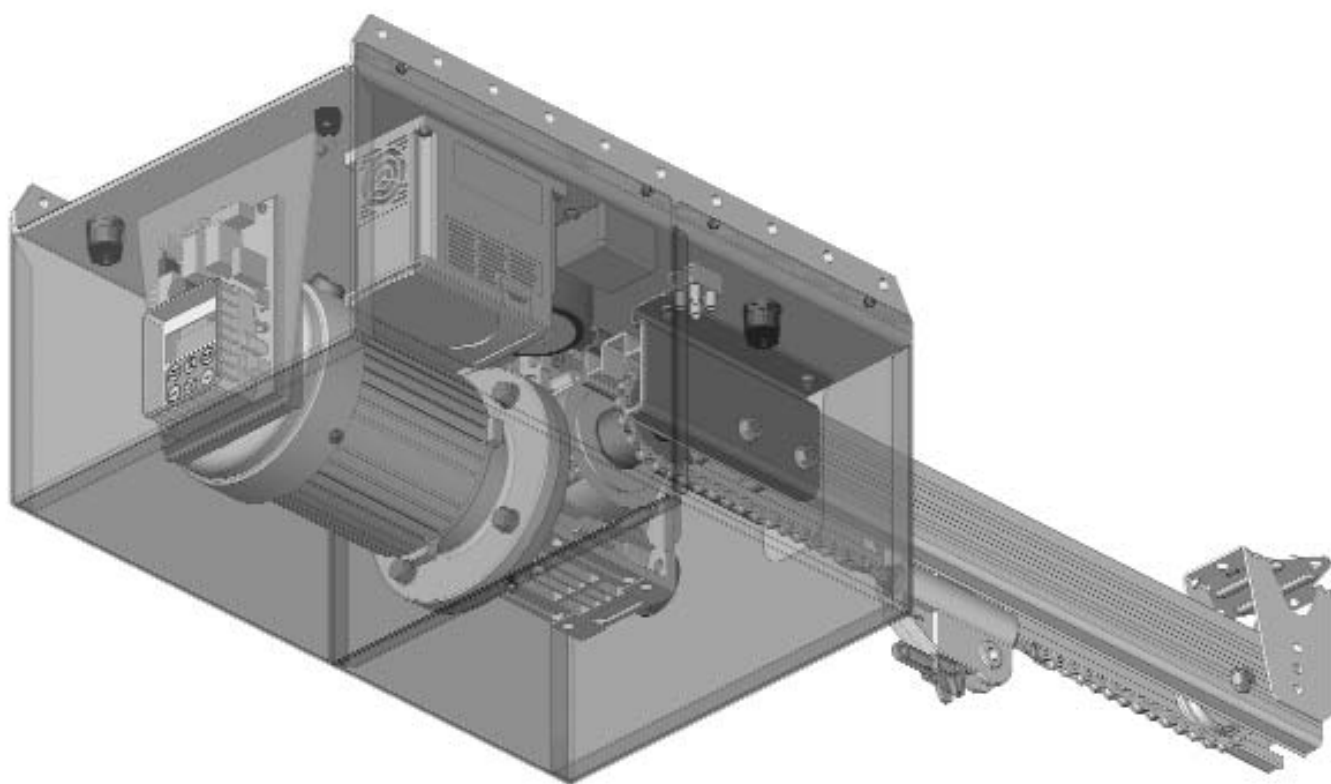

NOTE: A Photo Electric Beam Sensor must be fitted with this opener. Failure to comply will void the warranty and may cause serious personal injury and/or property damage.

OWNERS COPY

Installation Instructions

WARNING

It is vital for the safety of persons to follow all instructions. Failure to comply with the installation instructions and the safety warnings may result in serious personal injury and/or property and remote control opener damage. Please save these instructions for future reference.

















CONTENTS

PAGE	CONTENTS
3	IMPORTANT SAFETY WARNINGS
4	FEATURES
5	PRODUCT DESCRIPTION
5	BEFORE DRIVE UNIT INSTALLATION
6	DRIVE UNIT INSTALLATION
7	CONTROL BOARD LAYOUT
8	WIRING DIAGRAM - THREE PHASE
9	SETTING TRAVEL LIMITS
11	SETTING PEDESTRIAN POSITION
11	CHANGING ACCELERATE/DECELERATE SPEED
12	DESCRIPTION OF STANDARD OPERATION
13	MENU STRUCTURE
14	CONTROL BOARD ADJUSTMENTS
14	MENU 3 AUTO-CLOSE TIMES
15	MENU 4 LOCK TIMES
15	MENU 5 LIGHT TIMES
15	MENU 6 MOTOR SETTINGS
16	MENU 7 OPERATING MODES
17	PARAMETER VIEWING AND EDITING
18	CODING TRANSMITTERS
19	TRANSMITTER EDIT PROCEDURE
20	TRANSMITTER LIST MANAGEMENT
21	CODE OPERATION (LOCATION EMPTY)
21	CODE OPERATION (LOCATION USED)
21	DELETE OPERATION
21	EDIT OPERATION
21	COPY OPERATION
22	REMOTE CODE SET PROCEDURE
23	DIAGNOSTIC TOOLS (MENU 8)
23	MENU 8.1 TEST INPUTS
23	MENU 8.2 TEST TX'ERS
23	MENU 8.3 DISPLAY HISTORY
23	MENU 8.4 MEMORY USAGE
24	MENU 8.5 SERVICE COUNTER
24	MENU 8.6 COUNTERS
24	MENU 8.7 INSTALLATION
24	MEMORY TOOLS (MENU 9)
24	MENU 9.1 CLR CONTROL
24	MENU 9.2 CLR TX'ERS
24	MENU 9.3 BACKUP MEMORY
24	MENU 9.4 RESTORE TX'ERS
24	MENU 9.5 IMPORT LABELS
25	ACCESSORIES INSTALLATION
26	TROUBLE SHOOTING GUIDE
26	SYSTEM SPECIFICATIONS
27	PARTS LIST
28	WARRANTY AND EXCLUSION OF LIABILITY

Automatic Technology Australia Pty Ltd to the extent that such may be lawfully excluded hereby expressly disclaims all conditions or warranties, statutory or otherwise which may be implied by laws as conditions or warranties of purchase of an Automatic Technology Australia Pty Ltd automatic opener and Automatic Technology Australia Pty Ltd hereby further expressly excludes all or any liability for any injury, damage, cost, expense or claim whatsoever suffered by any person as a result whether directly or indirectly from failure to install the Automatic Technology Australia automatic opener in accordance with these installation instructions.

PLEASE READ THESE IMPORTANT SAFETY RULES

Warning - It is vital for the safety of persons to follow all instructions. Failure to comply with the following Safety Rules may result in serious personal injury and/or property damage.

-  For **SAFETY** protection a Photo Electric Beam **MUST** be fitted with this opener. Failure to comply **will** void the warranty and may result in serious personal injury and/or property damage
-  **DO NOT** operate the opener unless the door is in full view and free from objects such as cars and children/people. Make sure that the door has finished moving before entering or leaving the driveway.
-  **DO NOT** operate the opener when children/persons are near the door. Children must be supervised near the door at all times when the opener is in use. **SERIOUS PERSONAL INJURY** and/or property damage can result from failure to follow this warning.
-  **DO NOT** allow children to operate the opener. **SERIOUS PERSONAL INJURY AND/OR PROPERTY DAMAGE** can result from failure to follow this warning.
-  Make sure that the **SAFETY OBSTRUCTION DETECTION** system is working correctly, and is **TESTED** every month. Test as per the Installation Instructions Manual. Adjust if necessary and recheck. Failure to follow this rule could result in **SERIOUS PERSONAL INJURY** and/or property damage. This test must be repeated at regular intervals and the necessary adjustments made as required.
-  If using a key switch or keypad or any device that can operate the opener, make sure it is out of reach of children and that the doorway is in full view at all times.
-  Make sure that remote controls are kept out of reach of children.
-  The opener is not showerproof - it should not be immersed in water or sprayed directly by a hose or other water carrying device.
-  The door must be **WELL BALANCED** and in good working order. A faulty door must be repaired by a qualified technician prior to opener installation.
-  **REMOVE OR DISENGAGE** all locks and mechanisms prior to installation of the opener.
-  Keep hands and loose clothing **CLEAR** of the door and opener at all times.
-  When using auto close mode a **PHOTO ELECTRIC BEAM** must be fitted correctly and tested for operation at regular intervals. **EXTREME CAUTION** is recommended when using auto close mode. **ALL SAFETY RULES** above must be followed.
-  In order for the opener to **SENSE** an object obstructing the doorway, some **FORCE** must be exerted on the object. As a result the object, door and/or person may suffer **DAMAGE or INJURY**.
-  Make sure that the door is fully open before driving into or out of the driveway. And make sure the door is fully closed before leaving the driveway.
-  The opener is not intended for use by young children or infirm persons without adequate supervision. Children should be supervised to ensure that they do not play with the remote transmitters or the opener.
-  Frequently examine the installation, in particular guides and mountings for signs of wear, damage or imbalance. **DO NOT** use if repair or adjustment is needed since a fault in the installation or an incorrectly balanced door may cause injury.

PLEASE READ THIS INSTRUCTION MANUAL BEFORE ATTEMPTING TO INSTALL OR USE THE OPENER. FAILURE TO COMPLY WITH THE INSTALLATION INSTRUCTIONS MAY RESULT IN SERIOUS INJURY AND/OR PROPERTY DAMAGE.

FEATURES

Thank you for purchasing the ATA Axess Automatic Opener. This opener is designed to suit commercial heavy duty panel or sectional doors. The components and materials used in this opener are of the latest technology and highest quality. Listed below are some of the many features.

OPERATION

To operate the door opener simply activate one of the integrated controller's inputs using a remote control transmitter, keypad or many other devices such as key switch, swipe card, loop detector, etc. In response the door will then open, stop or close as requested. The opener can also be configured to close automatically using one of several auto-close modes.

OPERATOR CONSOLE

Incorporated into the integrated controller is a simple to use operator console which consists of several buttons and a display. The console offers a user friendly menu system that greatly simplifies installation, adjustment and status indication. Features include editing transmitter storage and names, setting various parameters, selecting specialised operating modes and performing system diagnostics.

STATUS INDICATION

The status of the door opener can be determined at anytime by observing the console's screen. When the MAIN SCREEN is displayed, the current position of the door or the result of the last movement can be found. The display will also show the count down progress of the auto-close timers. Any active input will also be displayed along with the state of various features such as periodic service.

HOPPING CODE TRANSMITTERS

The opener incorporates SecuraCode® hopping code remote control receiver. Hopping code transmitters generate a new encrypted access code (chosen at random) each time they are activated. As the receiver is able to track the encryption sequence and reject access codes that have already been received, it is able to reject unauthorised access requested attempted by thieves. In addition to this, each transmitter has a unique serial number - so no two are alike. Further, with a huge error rejection rate which allows less than one error in 10^{19} (10 quintillion), the security of the remote control system is greatly enhanced.

SECURITY CODE STORE

The opener uses state of the art technology in storing your selected transmitter codes. Up to 511 different transmitters can be stored in the opener's memory with the facility to assign a 11 character name to each transmitter.

REMOTE LIMITS POSITIONING

During installation, a hand held transmitter can be used when setting the door travel limits. This allows the installer to closely observe and control the doors movement from any position rather than having to be within arms reach of the console.

CONTROLLING LOCK AND LIGHTS

The controller has dedicated outputs for operating a electric lock and warning or courtesy lights. The timing of these outputs can be adjusted to suit your needs.

EXTENSIVE OPERATING MODES VIA CONTROL INPUTS AND REMOTE CONTROL

The integrated controller can be configured to operate in many different ways via its 7 control and safety inputs which include P.E, OPEN, STOP, CLOSE, OSC, SWIPE and PEDESTRIAN. Remote control operation is provided with each transmitter's button being able to be configured to operate one of OSC, PEDESTRIAN, SWIPE, CLOSE, OPEN, STOP, LIGHT or VACATION functions. The controllers functionality is further enhanced by 4 auto-close modes, 3 P.E response modes and two pedestrian response modes. For details refer to relevant instruction manual sections.

MANUAL OPERATION

The opener is equipped with a unique manual operation device. If the power to the opener is disrupted for any reason the shuttle can be disengaged and the door can move manually. When power is restored simply re-engage the shuttle to resume automatic operation.

PRODUCT DESCRIPTION

The ATA Axess Pro Series 1300 Panel Door Opener consists of a drive unit with integrated logic controller, aluminium channel and photo electric beam sensor.

LOGIC CONTROLLER

Housed along-side the drive motor and gearbox is a set of magnetic contactors and intelligent logic controller with menu driven LCD display. The controller offers a range of trigger inputs and door operation parameters. A 415V three phase power is required direct connection.

MECHANICAL DRIVE UNIT

The drive unit consists of a powerful three phase motor, rugged cast aluminium gearbox and position encoder. The aluminium track has a channel for running cables for PE Beams etc.

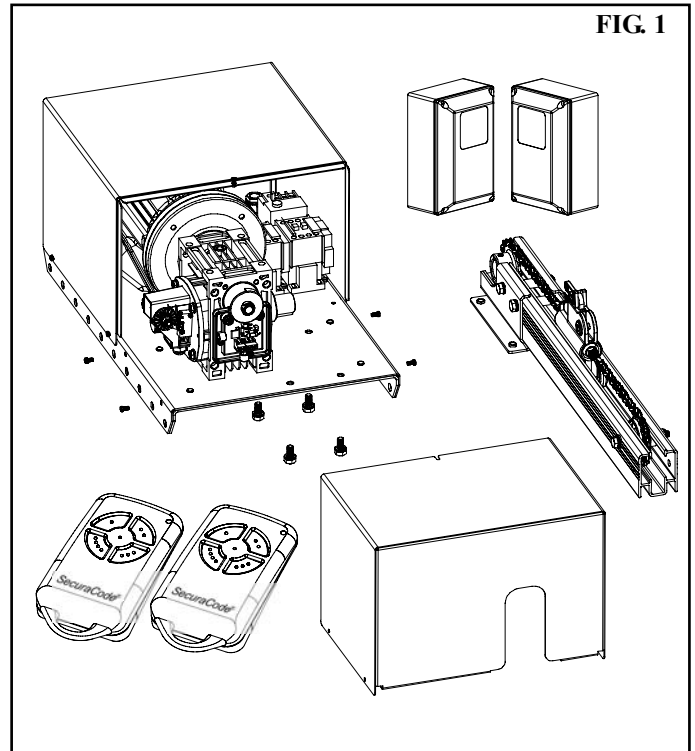

BEFORE DRIVE UNIT INSTALLATION

The ATA Axess Pro Series 1300 Panel Door Opener is designed to operate most commercial heavy duty and heavy residential panel or sectional overhead doors. The doors must be in good working condition and travel freely in the guides.

INITIAL CHECK

Before commencing installation check the following:

1. The door moves freely for the full travel in both directions.

2. The mounting must be solid construction (concrete, brick or steel. It must be able to withstand the full force applied to the door.
3. There is a 415V three phase power).
4. Photo-electric Beams must be installed. They should be located as close to the door as practicable.

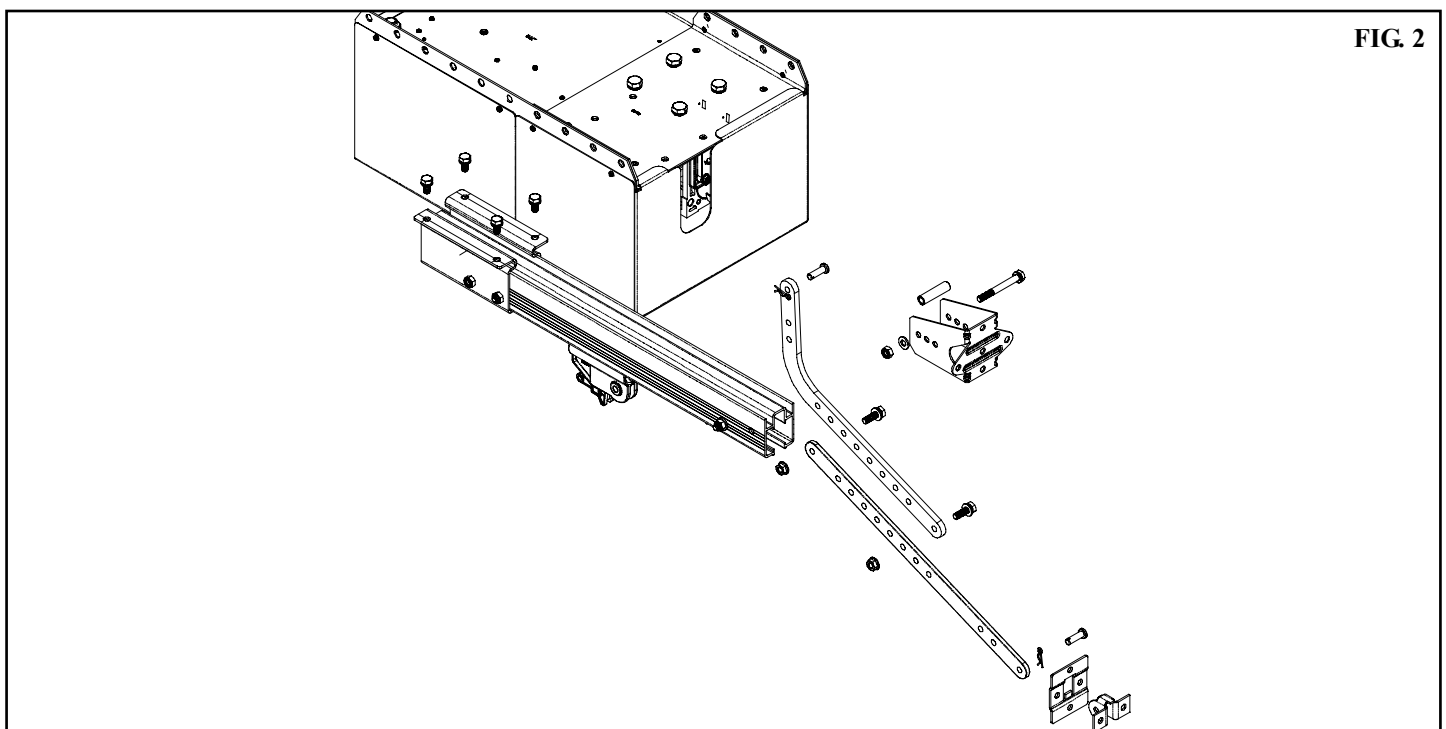

DRIVE UNIT INSTALLATION

DRIVE UNIT PRE-ASSEMBLY

The drive unit and track assembly are supplied as two separate parts. The drive sprocket is part of track assembly.

1. To connect track to drive unit remove front cover.
2. Disconnect trolley from chain index (**Fig.2**).
3. Loosen tension on chain. Do not disconnect chain.
4. Locate sprocket keyway with keyway on Reducer and slide it in place until face of sprocket boss sits against shoulder on reducers drive shaft.

Note: The whole track has to slide with sprocket. It can be knocked on with a mallet or "helped" with a screw driver.

5. Once sprocket is in position, lock cap head screw
6. Secure track to drive unit using M8 x 14 Hex Head screws.
7. Tighten chain and lock it with lock nuts.

MOUNTING THE DRIVE UNIT

1. Determine the centre of the door and mark this point on the wall above (**Fig. 3**).
2. Raise the door to open position (**Fig. 4**).
3. Rest the opener on a support above the top edge of the door to allow for a 25mm gap between the shuttle and the door.
4. Mark the position of the bracket on the wall above the door (**Fig. 5**).
5. Secure bracket in place with loxins or appropriate fasteners.
6. Secure the opener to the ceiling above drive unit mounting holes, with perforated angle or similar (not supplied). Do not lock screws at this stage.
7. The door bracket comes in two parts. The top plate is placed over the bottom plate and uses 4 mounting holes for extra strength. Mount the door bracket to the centre line of the door (**Fig. 6**), using M6 or equivalent screws (not supplied) Alternatively it can be welded on steel doors.

Note: As various types of doors exist, if in doubt about the strength of the door, reinforcement may need to be added to the frame of the frame or panel where necessary. Damage to the door panel may occur if the bracket is installed incorrectly on a panel with insufficient strength. The door opener warranty does not cover damage caused by the opener to the door and/or door panel.

8. Assemble bent and straight arm with screws, plain and spring washer and nuts supplied in accessory pack (**Fig. 7**).
9. Connect assembled arm to the door bracket and the trolley by clevis pin and spring clip.

Note: Shuttle must be in disengage position. Always use both bent & straight arm. If installing on a door with bad wave action, lengthening the arm even further will assist the door operation by reducing the wave action.

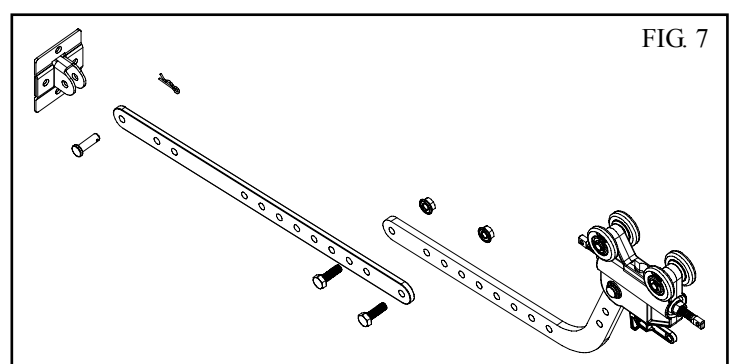
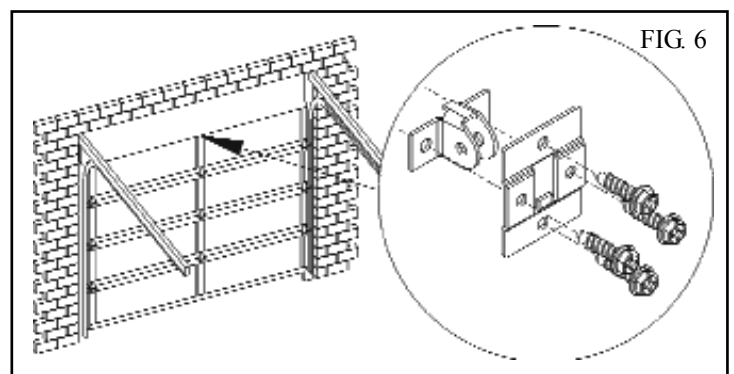
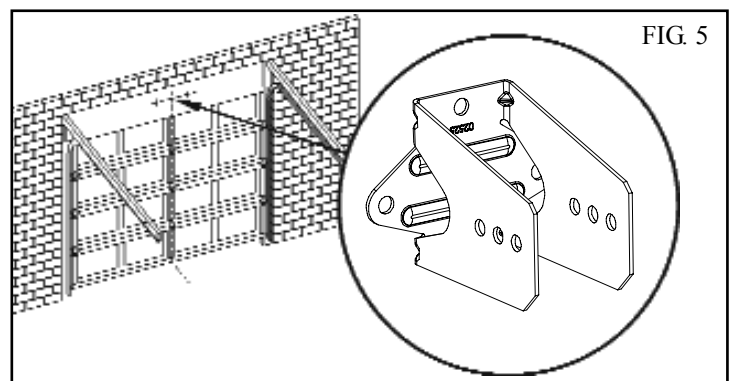
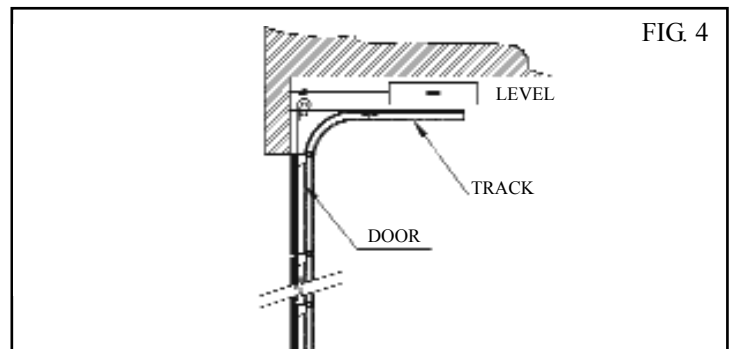
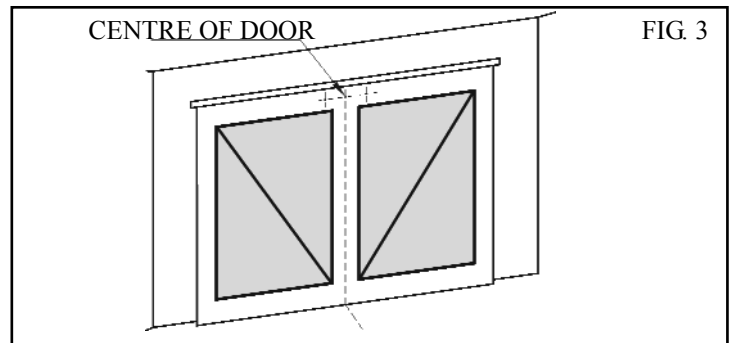

CONTROL BOARD LAYOUT

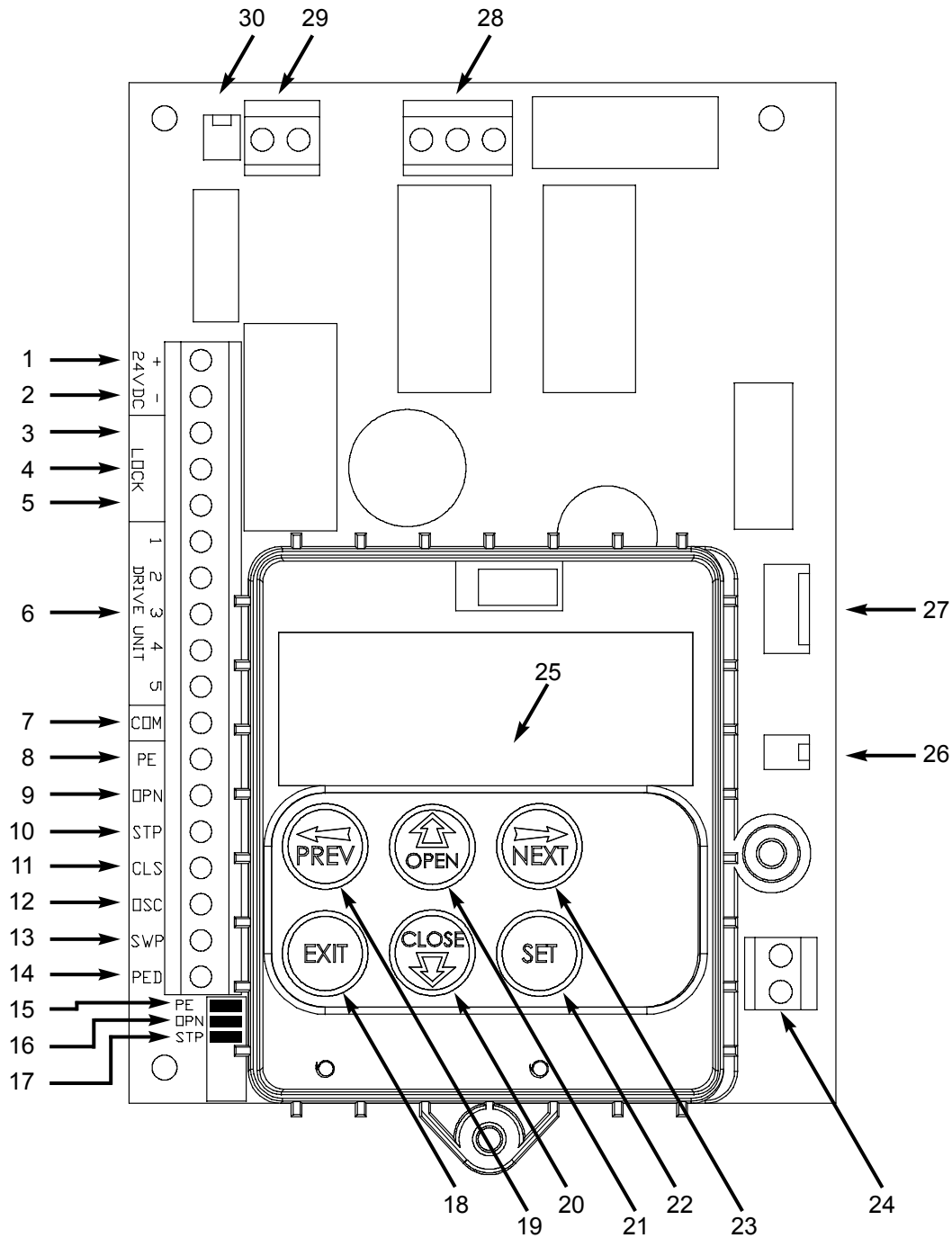

- | | | | |
|--------|---|-----|---|
| 1 & 2. | 24VDC output for powering accessories 3A(max) | 17. | STP Input Jumper (remove when 10 is used) |
| 3. | Lock relay output N/C contact | 18. | Console Exit Button |
| 4. | Lock relay output COM contact | 19. | Console Previous Button |
| 5. | Lock relay output N/O contact | 20. | Console Down/Close Button |
| 6. | Drive unit connections | 21. | Console Up/Open Button |
| 7. | COM terminal for inputs terminals 8..14 | 22. | Console SET Button |
| 8. | P.E N/C input terminal | 23. | Console Next Button |
| 9. | OPN N/C input terminal | 24. | Antenna Connector |
| 10. | STP N/C input terminal | 25. | Console Display |
| 11. | CLS N/O input terminal | 26. | Motor Speed Connector |
| 12. | OSC N/O input terminal | 27. | Programmer Interface Connector |
| 13. | SWP N/O input terminal | 28. | Motor Control Connector |
| 14. | PED N/O input terminal | 29. | 24V AC Power Supply |
| 15. | PE input jumper (remove when 8 is used) | 30. | Light Module Interface Connector |
| 16. | OPN input jumper (remove when 9 is used) | | |

WIRING DIAGRAM THREE PHASE

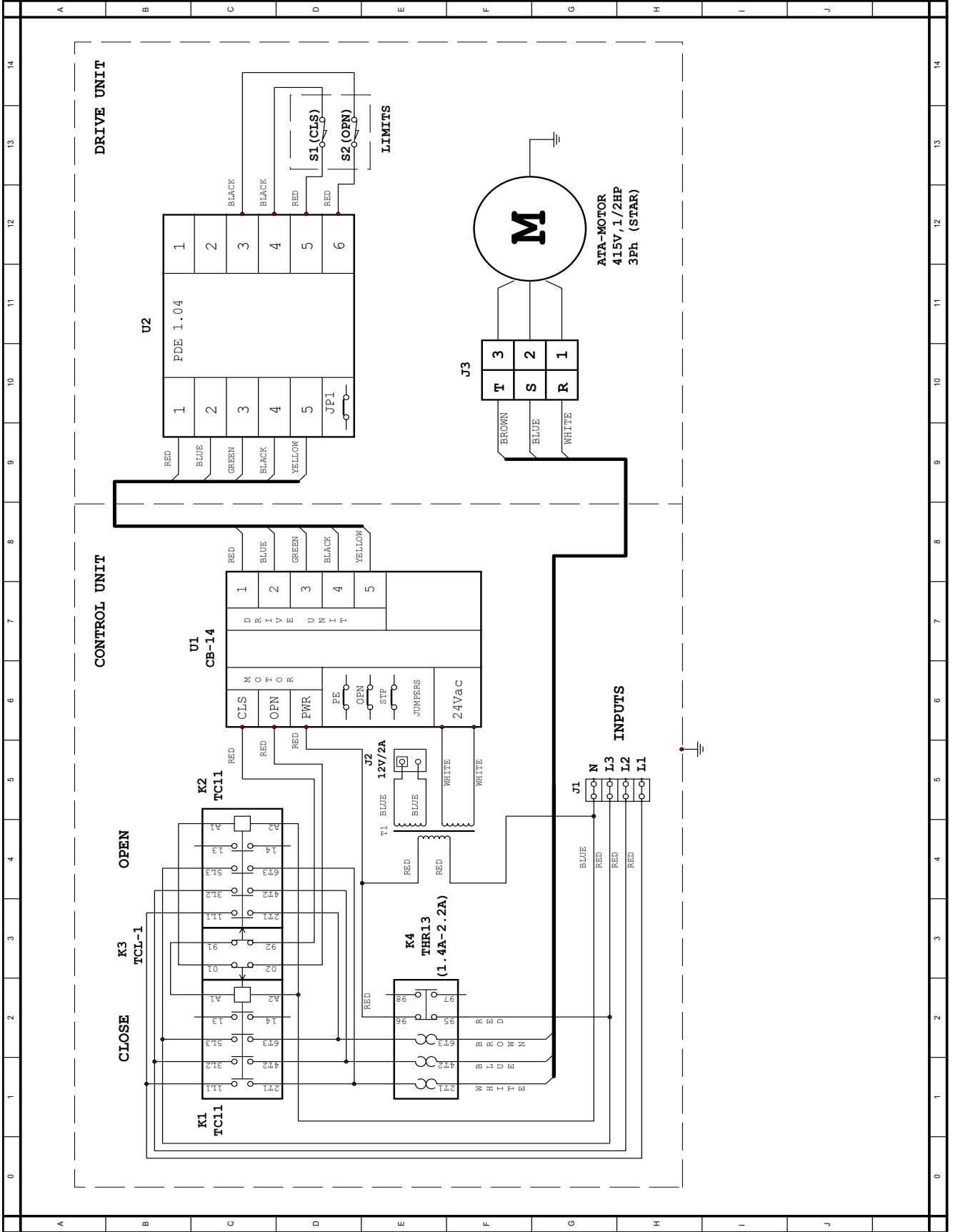

SETTING TRAVEL LIMITS

CAUTION:
CABLES WHICH HAVE A GREEN/YELLOW COLOURED INSULATION ARE FOR EARTHING PURPOSES ONLY. NEVER USE THESE CABLES FOR ANY OTHER PURPOSE.

This section shows how to set the travel limits. The procedure can be partly completed using a transmitter. In order to use a transmitter it must first have at least one of its buttons coded to the controller. The function assigned to the transmitter's buttons is of no concern here as the buttons are temporally assigned to OPEN, CLOSE and SET.

Note: The limit setting procedure can be aborted at anytime by pressing EXIT.

INSTALLING ANTENNA

If the installation requires remote transmitters, an external antenna is required. Mount the antenna as high as possible for optimal reception. Do not cut the coaxial cable.

POWERING UP

Connect to power. The controller will go through a startup sequence displaying the STARTUP SCREEN which indicates the controller type and firmware version (Fig. 8).

After a short delay the MAIN SCREEN will be displayed. If this is the first time the controller has been used the MAIN SCREEN should indicate that the limits are not set. If the display shows that an input is active then rectify the situation before continuing with the procedure for setting the travel limits for the door (Fig. 9).

Note: Door should be moved manually to half open position.

STEP 1. NAVIGATING TO "SET DOOR TRAVEL MENU"

1. Press PREV to navigate to the Menu 10 (Fig. 10).
2. Press SET to display MENU 10.1.
3. Press SET again to enter the limit setting procedure.

STEP 3. SELECTING MOTOR ENCODER MODE

The motor encoder is used to determine motor load and relative position to the travel limits..

1. Press OPEN or CLOSE until "On" is displayed.
2. Press SET to continue (Fig. 11).

STEP 4. SELECTING SPEED RAMPING MODE

For the Axess Series 1300 model select 'Off' using the OPEN or CLOSE buttons and then press SET (Fig. 12).

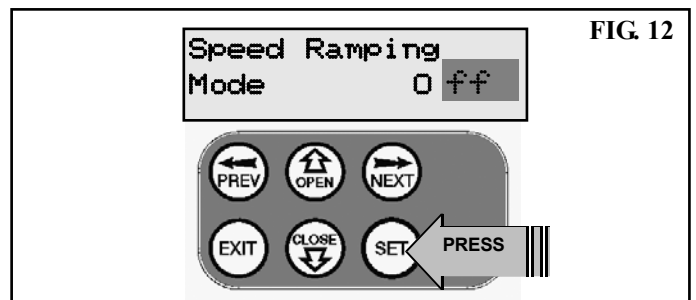
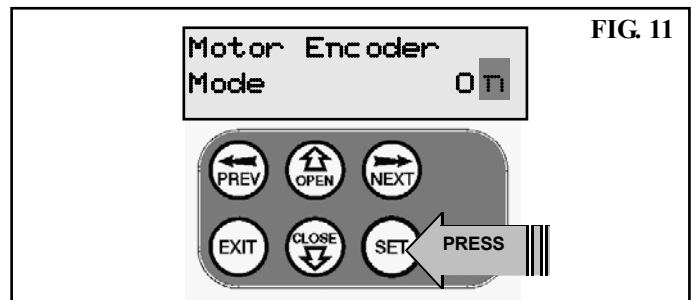
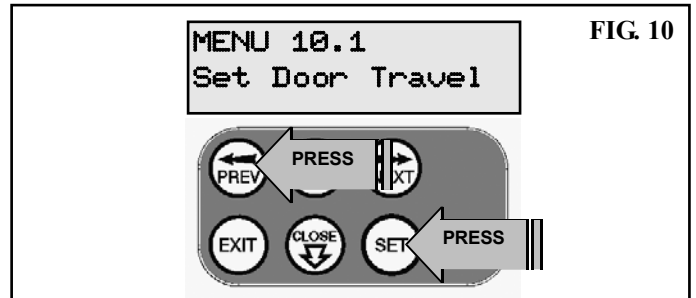
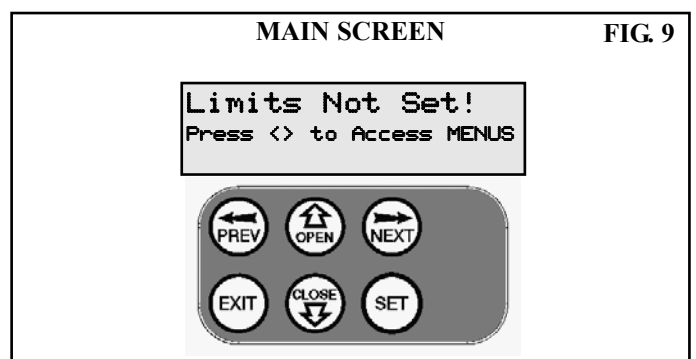
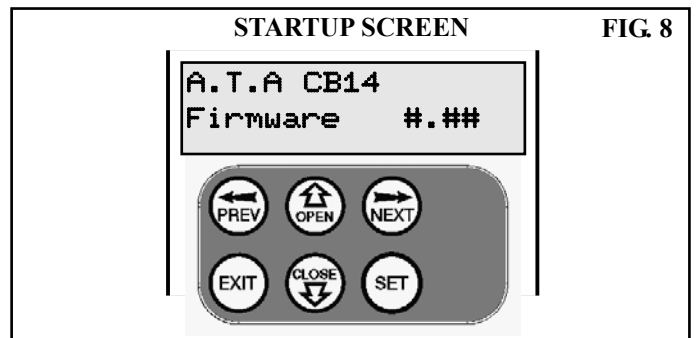

SETTING TRAVEL LIMITS

STEP 5. SETTING CLOSE TRAVEL LIMIT

1. Press CLOSE to move door to the desired CLOSE LIMIT.
(Or Press button 4 on transmitter) (Fig. 13).
2. Rotate red CLOSE limit cam until switch is activated (Fig. 13).

Note: If the limit cam engages before the door reaches the required position, adjust the cam back to allow for additional door travel.

3. Press SET to record the CLOSE LIMIT.
(Or press button 2 on Transmitter).

Note: Limit will not be accepted unless the door is driven in the close direction.

STEP 6. SETTING OPEN TRAVEL LIMIT

1. Press OPEN to move door to the desired OPEN LIMIT.
(Or Press button 1 on transmitter) (Fig. 14).
2. Rotate green OPEN limit cam until switch is activated.

Note: If the limit cam engages before the door reaches the required position, adjust the cam back to allow for additional door travel.

3. Press SET to record the OPEN LIMIT.
(Or press button 2 on Transmitter).

Note: Limit will not be accepted unless the door is driven in the open direction.

WARNING: If tightening cam retaining bolt use two spanners and DO NOT over tighten. It requires no more than a quarter turn of the spanner.

AUTOMATIC LIMIT ADJUSTMENT AND LOAD PROFILE

After a brief pause the controller will automatically close and open the door several times to learn the normal load profile of the door and the normal travel times. When the setup is complete the MAIN SCREEN will be displayed with the door shown to be Closed. The door can now be used.

Note: Do not press transmitter during limit adjustment process.

PEDESTRIAN ACCESS POSITION

After completing the above procedure the Pedestrian access position is automatically set to a position which is in the middle of the gate travel. The position can be manually set by following the SETTING PEDESTRIAN POSITION procedure.

ERRORS DURING SETTING OF TRAVEL LIMIT

During the above procedure many error checks are performed. If an error is detected a message will be displayed indicating the error.

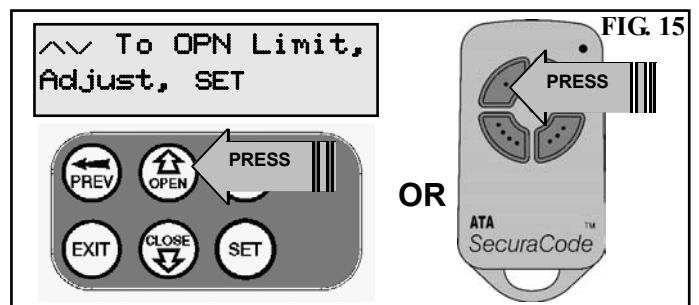
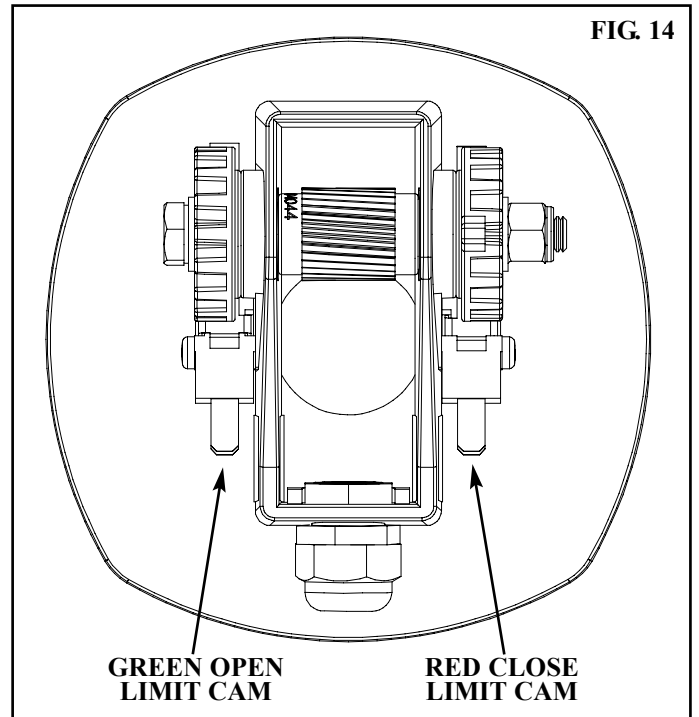
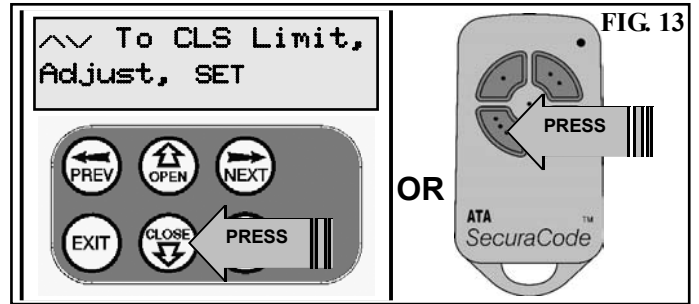

SETTING PEDESTRIAN POSITION

FOR OPENERS WITHOUT AN ENCODER FITTED.

Note: Before setting the pedestrian access position the door must be in the fully closed position. As with the Setting Travel Limit procedure, a transmitter can be used to complete the pedestrian position setting procedure.

STEP 1. NAVIGATING TO “SET PEDESTRIAN MENU”

1. Press PREV to navigate to the Menu 10 (Fig. 16).
2. Press SET - MENU 10.1 is displayed.
3. Press NEXT to go to MENU 10.2.
4. Press SET to enter Set Pedestrian procedure.

STEP 2. SETTING PEDESTRIAN POSITION

1. Press OPEN to move gate to desired pedestrian access position.
(Or press button 1 on transmitter) (Fig. 17).
2. Press SET to record position.
(Or press button 2 on transmitter).

STEP 3. PEDESTRIAN POSITION SET

The controller will return to the MAIN SCREEN with the gate status shown as being in pedestrian access mode (Fig. 18).

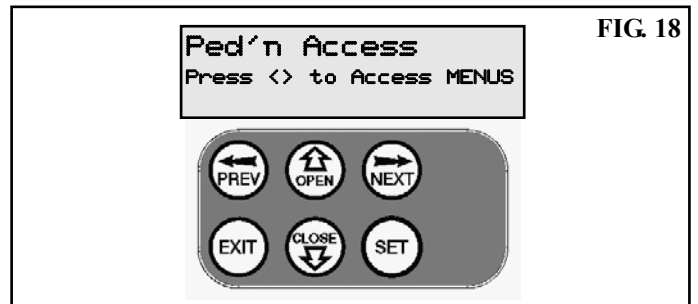
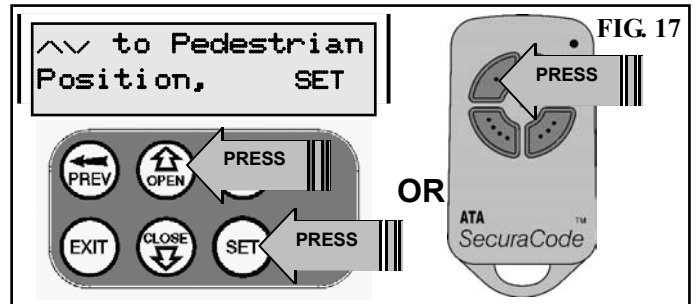
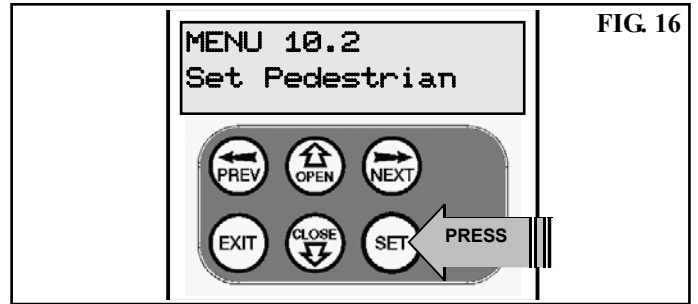

DESCRIPTION OF STANDARD OPERATION

This section describes the standard operation of the control board with the factory set default values.

MOTOR CONTROL.

The controller drives the motor in the appropriate direction as instructed by the control inputs. Once a cycle is started the motor will continue to travel until:

- 1.The controller is instructed to stop by a control input.
- 2.The motor's travel limit is reached.
- 3.A motor is obstructed, overloaded or stalls

When the control inputs instruct the control board to change the motor direction, the controller turns off the motor, waits for the motor to stop and then starts the motor in the other direction.

MOTOR OBSTRUCTION DETECTION

This feature is only enabled if an encoder is fitted to the opener and the encoder option is selected during the travel limit setup.

If a motor is obstructed while opening, the motor is stopped. If a motor is obstructed while closing, the motor is stopped and then reversed to the open position. Obstruction detection is achieved by monitoring the motor's speed and comparing it to the "normal" speed profile. If the speed of the motor falls below the "normal" by the MARGIN RPM setting, then the motor is said to be obstructed. In addition to the normal motor obstruction detection, motor overload, stall detection and excessive travel time detection is provided to protect the door and opener.

LOCK RELEASE OUTPUT

The lock release output is configured to pulse for 0.5 seconds at the start of each cycle. The output is turned on at the same time the motor is started.

COURTESY LIGHT

With the addition of a module which plugs into the control board, the control board will control a courtesy light. The light is normally used to illuminate the driveway etc. The light will be turned on each time the door is activated (day or night) and automatically turned off 1 minute after the drive cycle has finished. The light can also be activated and deactivated by pressing a transmitter button assigned the LGT function.

OPEN/STOP/CLOSE (OSC) INPUT

(Activated by OSC terminal with N/O switch or by transmitter button with OSC function assigned)

If the door is stopped the OSC input will cause the door to move in the opposite direction to that last travelled. If the door is moving the OSC input will cause the door to stop.

PEDESTRIAN ACCESS (PED) FUNCTION

(Activated by PED terminal with N/O switch or by transmitter button with PED Function assigned).

The pedestrian access operation partly opens the door allow pedestrian access but prevent vehicle access. The position the door is driven to is automatically set to halfway during setting of the travel limits, but can be manually adjusted. Pedestrian access mode is entered when the input is activated and the door is in the closed position. If the door is not in the pedestrian access mode, the PED input will stop the door, if moving, or close the door, if

stopped. While in pedestrian access mode, the pedestrian access position temporarily becomes the open limit for the door. The PED input then acts with an OSC type function. The pedestrian access mode is exited when the door is closed or when another input is activated.

CLOSE (CLS) INPUT

(Activated by CLS terminal with N/O switch, by transmitter button with CLS function assigned or by console's CLOSE button).

Activating the CLS input will cause the door to close. Holding the input active will prevent opening.

SWIPE (SWP) INPUT

(Activated by SWP terminal with N/O switch or by transmitter button with SWP function assigned).

Activating the the SWP input will cause the door to be opened. If the terminal input is held it will prevent the door being closed. The swipe input also effects P.E TRIGGERED AUTO CLOSE.

OPEN (OPN) INPUT

(Activated by OPN terminal with N/C switch, by transmitter button with OPN function assigned or by console's OPEN button)

Activating the OPN input will cause the door to open. Holding the input will prevent closing.

STOP (STP) INPUT

(Activated by STP terminal with N/C switch, by transmitter button with STP function assigned or by console's EXIT button)

Activating the STP input while the door is moving will cause the door to be stopped. If the STP terminal is held it will prevent the door from being moved.

PHOTOELECTRIC SAFETY BEAM (P.E) INPUT

(Activated by PE terminal with N/C switch)

When the P.E input is active, the door is prevented from being closed. If the P.E input is triggered while the door is closing, the controller will stop the motors and then open the door. The P.E input has no effect while the door is opening.

VACATION MODE

The controller supports a vacation mode where remote control access is disabled. The mode is activated by pressing a transmitter button with the VAC function assigned until the console displays that vacation mode is enabled (approx. 5 seconds). When activated any transmitter button which is assigned VAC will be ignored. To turn the Vacation mode off simple press a transmitter button with the VAC function assigned (Only requires a brief activation.) Vacation mode can also be turned on or off manually by editing the VACATION MODE parameter.

MENU STRUCTURE

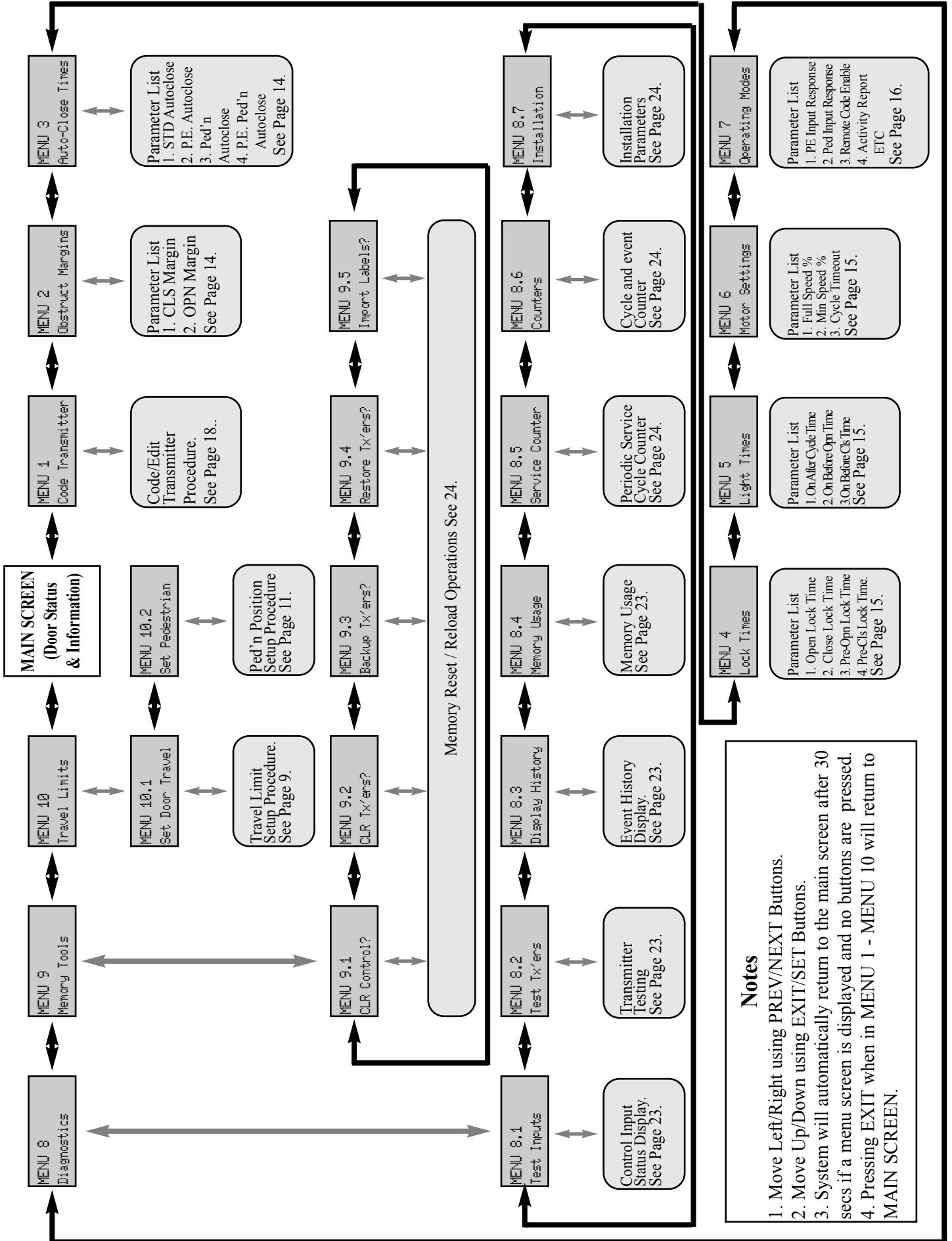

CONTROL BOARD ADJUSTMENTS

The opener's standard operation can be altered by editing various parameters. This section describes the parameters and the effect they have. Use the VIEWING AND EDITING PARAMETER PROCEDURE on Page 17 to make changes.

MENU 2 - OBSTRUCTION MARGINS

MARGINS

The obstruction margins are used to alter the sensitivity of the controller to obstructions. Increasing the value increases the allowable variation between the "normal" force profile and the actual force.

PARAMETER	MIN	MAX	DEFAULT	STEP	UNIT	MENU No.
CLS MARGIN Sets the obstruction detection margin for close cycles	0.0	250	100	10	-	2
OPN MARGIN Sets the obstruction detection margin for open cycles	0.0	250	100	10	-	2

MENU 3 - AUTO-CLOSE TIMES

The auto-close modes automatically close the door after it has been operated. To implement this, the controller starts a timer once the door has reached its desired open position. The timer then counts down and when it expires the controller starts to close the door. Details about the four auto-close modes follow. ATA strongly recommend using a PE Beam for added safety.

STANDARD AUTO-CLOSE

This mode is selected by entering a non-zero time for the **STD Autoclose** parameter. When selected the door will auto-close after being fully opened (except when the door has reversed to the open position after a motor obstruction or overload). Countdown is suspended by: the P.E, OPN or SWP input being active. The countdown is aborted if the STP input is activated. If the door is already open and the OPN or the SWP input is activated then the countdown will start.

P.E TRIGGERED AUTO-CLOSE

This mode is selected by entering a non-zero time for the "**P.E Autoclose**" parameter. This mode is used to auto-close the door but only after a vehicle have passed through the doorway and triggered the P.E input. The swipe input can be used to clear the P.E triggered status so that the P.E input must be activated again before the countdown will start. As with the other P.E modes the STP input will abort countdown and the OPN and SWP inputs will restart the countdown if the door is OPEN.

PEDESTRIAN ACCESS AUTO-CLOSE

This mode is selected by entering a non-zero time for the "**Ped'n A/C**" parameter. When selected the door will auto-close after being opened for pedestrian access unless it was following a reverse from an obstruction.

P.E TRIGGERED PEDESTRIAN AUTO-CLOSE

This mode is selected by entering a non-zero time for the "**P.E Ped'n A/C**" parameter. This mode is the same as the P.E triggered auto-close mode but it only operates during pedestrian access. As the SWP input is not available during pedestrian access, the PED input can be configured to act in a SWP mode by setting the "**PED I/P = PED SWIPE MODE**" parameter to **ON**.

AUTO-CLOSE AFTER OBSTRUCTION

Two parameters are provided to enable the auto-close feature to be activated after obstructions. Normally the auto-close feature is not enabled after obstructions for safety reasons. A P.E beam must be used for these features to be activated

PARAMETER	MIN	MAX	DEFAULT	STEP	UNIT	MENU No.
STD AUTOCLOSE TIME Sets and enables the standard auto-close time.	0.0	300.0	0.0	1.0	SEC	3
P.E AUTOCLOSE TIME Sets and enables the P.E triggered auto-close time.	0.0	300.0	0.0	1.0	SEC	3
PEDESTRIAN AUTOCLOSE TIME Sets and enables the Pedestrian auto-close time.	0.0	300.0	0.0	1.0	SEC	3
P.E PEDESTRIAN AUTOCLOSE TIME Sets and enables the PE Pedestrian auto-close time.	0.0	300.0	0.0	1.0	SEC	3
AUTOCLOSE AFTER CLOSE OBSTRUCTION Enables autoclose feature after close obstructions	OFF	ON	OFF			3
AUTOCLOSE AFTER OPEN OBSTRUCTION Enables autoclose feature after open obstructions	OFF	ON	OFF			3

CONTROL BOARD ADJUSTMENTS

MENU 4 - LOCK TIMES

Lock output can be programmed for both hold and pulse operation and can also be programmed to activate prior to the door motor starting. The operation of the lock can be programmed to behave differently on open cycle to that on close cycles.

PARAMETER	MIN	MAX	DEFAULT	STEP	UNIT	MENU No.
OPEN LOCK TIME Set the time the lock is activated for on open cycles	0.0	HOLD	0.5	0.1	SEC	4
CLOSE LOCK TIME Set the time the lock is activated for on close cycles	0.0	HOLD	0.5	0.1	SEC	4
PRE-OPEN LOCK TIME Time the lock is activated for prior to opening.	0.0	25.5	0.0	0.1	SEC	4
PRE-CLOSE LOCK TIME Time the lock is activated for prior to closing	0.0	25.5	0.0	0.1	SEC	4

MENU 5 - LIGHT TIMES

With the addition of a relay module connected to the control board, a light can be controlled. The time the light stays on, is controlled by two timers. The first times the period the light is activated for prior to a drive cycle. This is used to warn that door movement is pending. The second times how long the light remains on after a cycle. The parameters are shown below.

PARAMETER	MIN	MAX	DEFAULT	STEP	UNIT	MENU No.
ON AFTER CYCLE LIGHT TIME Time light remains on for after a cycle	0	255	60	1	SEC	5
ON BEFORE OPEN CYCLE LIGHT TIME Minimum time light is activated for prior to opening	0	255	0	1	SEC	5
ON BEFORE CLOSE CYCLE LIGHT TIME Minimum time light is activated for prior to closing	0	255	0	1	SEC	5

MENU 6 - MOTOR SETTINGS

MOTOR SPEEDS

When speed ramping is enabled during the limit setup procedure, the controller will ramp the motors speed up at the start of a cycle and then down again at the end of the cycle prior to stopping at the limit. The parameters for open and close speeds set the respective motor speeds for the open and close cycles. The minimum speed parameter sets the minimum speed output to the

motor at the start and end of ramping.

NOTE: Altering these parameters will cause the travel limits to be cleared.

CYCLE TIMEOUT

Sets the maximum time a cycle can run past its normal cycle time for before an obstruction is tripped.

PARAMETER	MIN	MAX	DEFAULT	STEP	UNIT	MENU No.
CLOSE SPEED Sets the motor speed for close cycles	1	100	100	1	%	6
OPEN SPEED Sets the motor speed for open cycles	1	100	100	1	%	6
MIN SPEED Minimum speed output to the motor	1	100	100	1	%	6
CYCLE TIMEOUT (NORM +) Cycle overrun time permitted before obstruction.	0.1	25.5	2.0	0.1	Sec	6

CONTROL BOARD ADJUSTMENTS

MENU 7 - OPERATING MODES

P.E INPUT RESPONSE MODE

The P.E input can be configured to respond in one of three modes.

OPEN AND CLOSE CYCLES STOP

In this mode all cycles are prevented from being completed or initiated when the P.E input is active.

CLOSE CYCLES STOP

In this mode the P.E input has no effect when opening but will stop the gate when closing.

REVERSES CLOSE CYCLES

In this mode the P.E input has no effect when opening but will cause the gate to reverse if activated when closing.

PED INPUT FUNCTION

The PED input can be configured to a SWIPE type input for pedestrian access. This provides full functionality with the P.E Triggered Pedestrian auto-close function.

REMOTE CODE

The controller supports the Remote Code Set feature. This parameter can be used to disable the feature for security or transmitter management reasons.

ACTIVITY REPORTS

This parameter enables activity report outputs. Contact ATA for more details.

ACTIVITY REPORT ID

This parameter sets the ID of the controller that is sent with the activity report. Contact ATA for more details.

VACATION MODE

Vacation mode can be turned on or off using this parameter.

BATTERY/SOLAR MODE

The controller can be instructed to turn off the battery backup facilities so that the control board can be shut down without having to disconnect the battery backup system.

PASSWORD PROTECTION

The password feature enables all parameters and configuration settings to be protected unless a password is entered. When this feature is turned on the user is requested to enter the desired password to be used. The password protection feature has a time-out that expires after 60 seconds of inactivity. Alternately the user may log out manually by pressing exit when the main screen is displayed.

OPEN INPUT POLARITY

The OPN input is normally configured for N/C operation. This parameter allows its operation to be changed to N/O.

PARAMETER	MIN	MAX	DEFAULT	STEP	UNIT	MENU No.
P.E INPUT RESPONSE MODE Sets the P.E response mode. Options are OPEN and CLOSE cycles stop, Close cycles stop or Close cycle reverse	OPN & CLS stop CLS to stop CLS to reverse		CLS to reverse			7
PED INPUT = SWIPE MODE Selects PED input functions as pedestrian access swipe input.	OFF	ON	OFF			7
REMOTE CODE ENABLED Selects remote transmitter coding function	OFF	ON	ON			7
ACTIVITY REPORTS Select report to be output	OFF	255	OFF	1		7
ACTIVITY REPORT ID Selects ID for controller, sent with activity report	0	65535	0	1		7
VACATION MODE Selects vacation mode - disables remote control.	OFF	ON	OFF			7
PASSWORD Selects password protection for all changes.	OFF	ON	ON			7
TX # GROUPING Selects tx'er number group display format.	OFF	ON	OFF			7
OPN INPUT N/O OPERATION Selects operating polarity of OPN input	OFF	ON	OFF			7

VIEWING AND EDITING PARAMETER

This section illustrates how to locate, view and adjust parameters.

LOCATING PARAMETERS

Refer to MENU STRUCTURE on Page 13 or the preceding section for CONTROL BOARD ADJUSTMENTS. Locate the required parameter and note the MENU number. The example in (Fig. 20) uses “CLOSE LOCK TIME” will be used as an example.

CHANGING SETTING

1. Press NEXT/PREV to navigate to the required menu.
2. Press SET to show sub menu.
3. Press NEXT/PREV to go to required submenu.
4. Press SET to enter edit mode.
5. Press UP/DOWN to change parameter setting.

Holding the button down causes the parameter’s value to change rapidly. The longer the button is held the faster the value changes.

6. Press SET to SAVE setting.

RELOAD DEFAULT SETTING

1. Press NEXT/PREV buttons to display LOAD DEFAULT screen.
2. Press SET to load the default value.

RETURN TO MENU

If the parameter’s value is not to be changed, press EXIT to return to sub menu. Press EXIT again to return to the MAIN SCREEN.

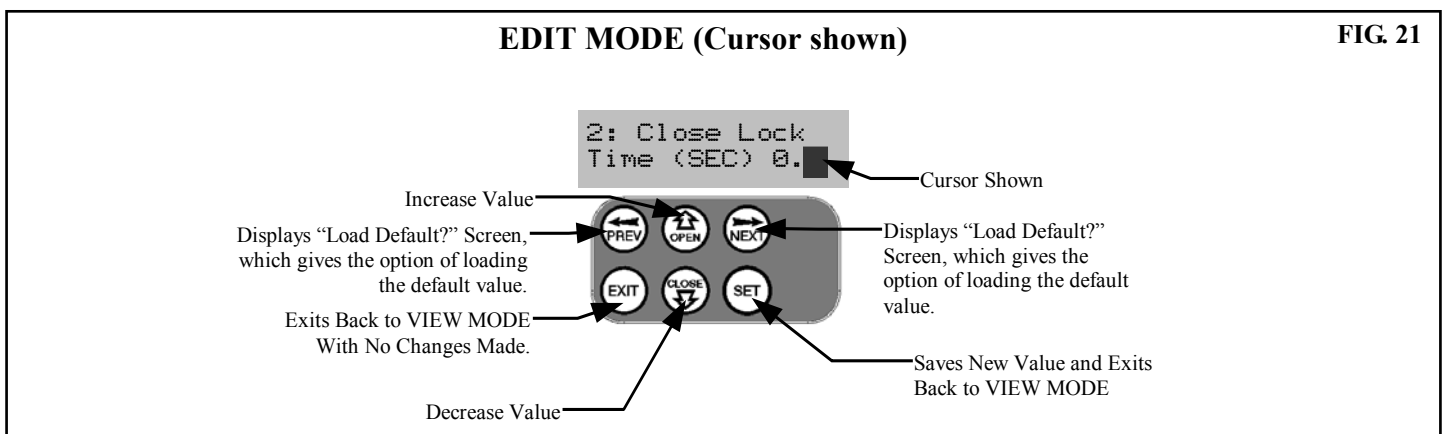
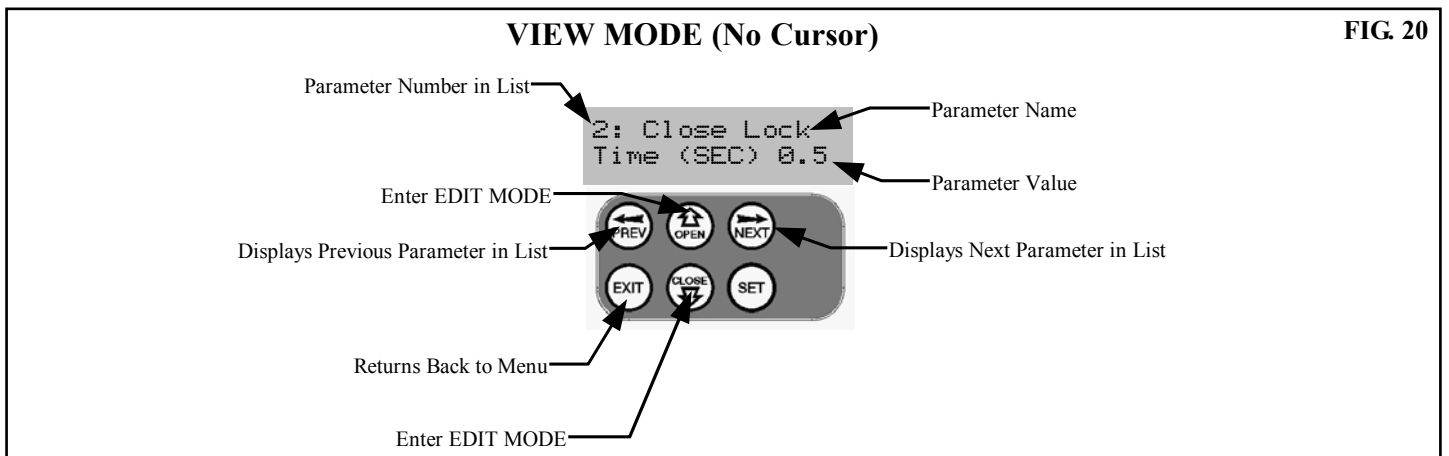

CODING TRANSMITTER

Up to 511 transmitters can be stored within the openers memory. Each transmitter can be allocated an alpha-numeric ID label up to eleven (11) characters in length and each button can be assigned to one of several control functions. The settings for a transmitter are represented in (Fig. 22). It shows the transmitter's store number, ID label or Serial number and the functions assigned to each of its four buttons. To toggle between ID/SN display, press UP/DOWN with the cursor on the ID/SN indicator. The procedures below code, delete, replace, edit and copy transmitter records.

CODING TRANSMITTER BUTTON

STEP 1. NAVIGATING TO "Code Transmitter" MENU

1. Press NEXT to navigate to the Menu 1 (Fig. 23).
2. Press SET to enter code set procedure.

STEP 2. STORING TRANSMITTER CODE

1. Controller will prompt to press one of the transmitter's buttons.
2. Press the transmitter button you wish to use to operate the door Opener (e.g. button 1) (Fig. 24).
3. Press same transmitter button again as prompted by display. (Fig. 25).

STEP 3. SELECTING FUNCTION OF THE BUTTON

The controller will now show the transmitter's record, with a cursor on the field for the button being coded (Fig. 26). Use UP/DOWN to select the function for the button.

AVAILABLE FUNCTIONS

VAC	(Vacation Mode)
LGT	(Courtesy Light)
STP	(Stop)
OPN	(Open)
CLS	(Close)
SWP	(Swipe)
PED	(Pedestrian access)
OSC	(Open/Stop/Close)
OFF	(No action)

Press SET to save the settings or EXIT to abort without saving (Fig. 27).

RETURNING TO MAIN SCREEN

The "Code Transmitter" menu will now be shown. Press EXIT to return to the MAIN SCREEN and test the transmitter.

Note: To edit the other settings, refer to **TRANSMITTER EDIT PROCEDURE**.

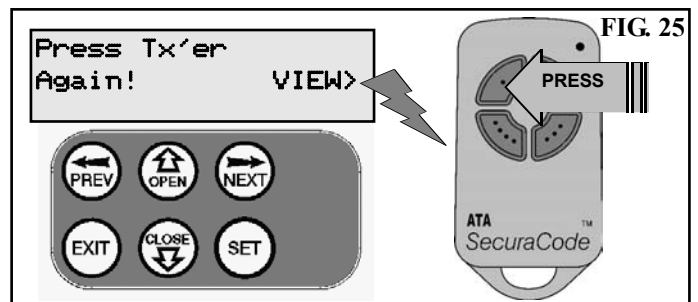
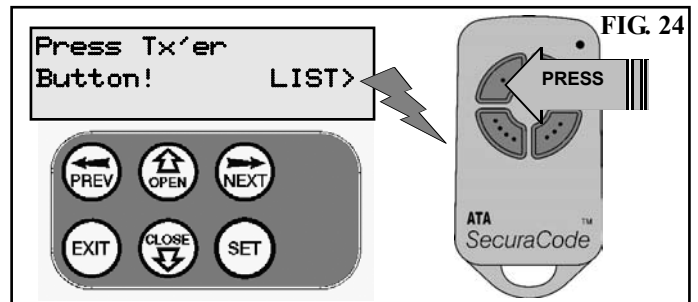
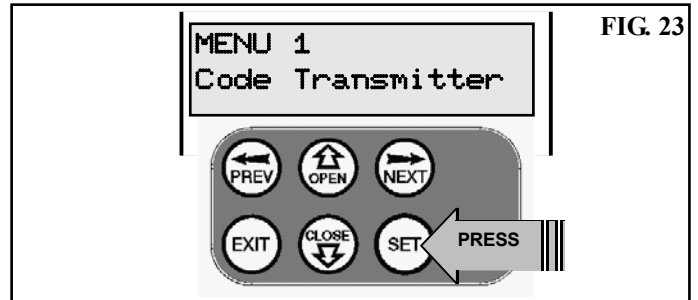
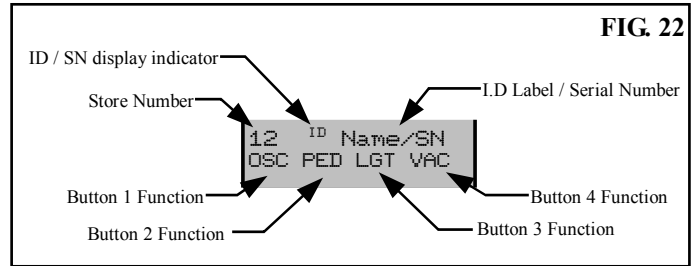

TRANSMITTER EDIT PROCEDURE

EDITING TRANSMITTER SETTINGS

STEP 1. DISPLAY TRANSMITTER RECORD

Using one of the methods below, display the required transmitters details.

STEP1. NAVIGATING TO “Edit Transmitter” MENU

1. Press NEXT to navigate to the Menu 1 (Fig. 23).
2. Press SET to enter the transmitter edit procedure.
3. Press NEXT to enter transmitter list and edit mode.

STEP 2. EDITING BUTTON FUNCTION FIELD

1. Press NEXT or PREV to move the cursor to the left or right and between the top and bottom lines to select the desired field.
2. Press UP or DOWN to change the displayed value (Fig. 28).

The available functions are shown below. Selecting OFF will prevent the opener responding to that button.

AVAILABLE FUNCTIONS

VAC	(Vacation Mode)	LGT	(Courtesy Light)
STP	(Stop)	OPN	(Open)
CLS	(Close)	SWP	(Swipe)
PED	(Pedestrian access)	OSC	(Open/Stop/Close)
OFF	(No action)		

3. Press SET to save changes or press NEXT or PREV to move to next field. The example in (Fig. 29) shows that PED is assigned to the transmitter button 2. The transmitter in the example is transmitter number 12 which has the ID label AB Smith.

Note: If all button functions are set to OFF, when SET is pressed, the opener will prompt to confirm if the transmitter is to be deleted. Press SET to delete or EXIT to continue editing.

STEP 4. EDITING THE STORE LOCATION

This feature is only available when coding the first button of a new transmitter.

1. Press NEXT or PREV to move cursor over Store No.
 2. Press UP or DOWN to select new Store No (Fig. 29).
 3. Press SET to Confirm or NEXT/PREV to move to next field.
- This is useful when managing transmitters using a scheme which ties the store location to the transmitter’s owner.

STEP 5. SELECTION OF ID OR S/N DISPLAY

1. Press NEXT/PREV to move cursor over ID field.
 2. Press NEXT to reveal Serial Number (Fig. 30).
- The serial number display is provided for additional means of identification. The transmitter in this example has S/N: 12345.

STEP5. EDITING A CHARACTER FIELD

1. Press NEXT or PREV to move select character to change.
2. Press UP or DOWN to scroll through and select new character.
3. Press NEXT or PREV to move to next character.
4. Repeat step 2.
5. Press SET to record changes.

The second line of the display shows a list of available characters with the current value indicated at the cursor position.

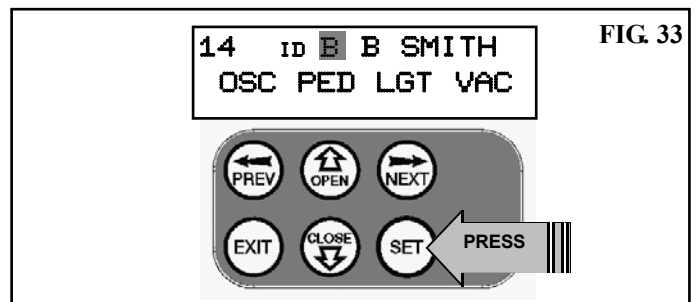
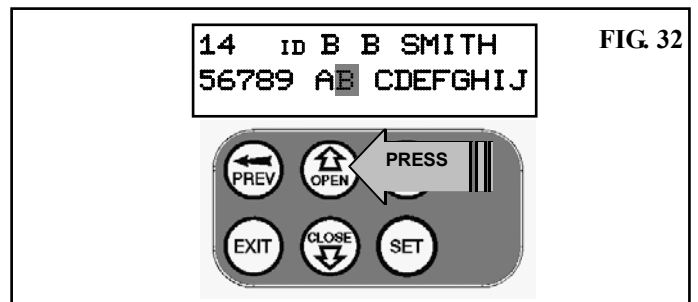
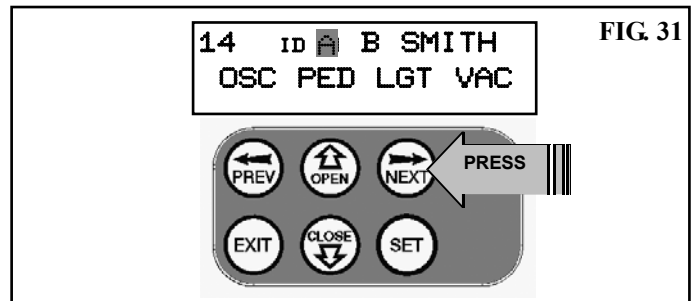
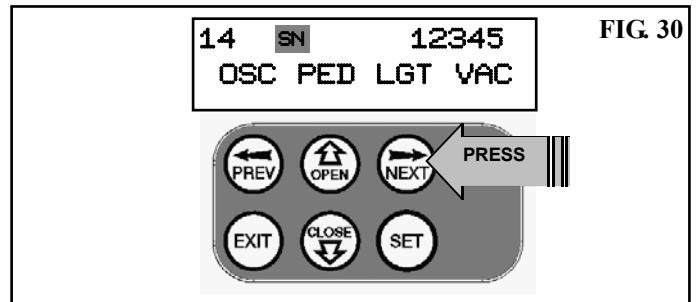
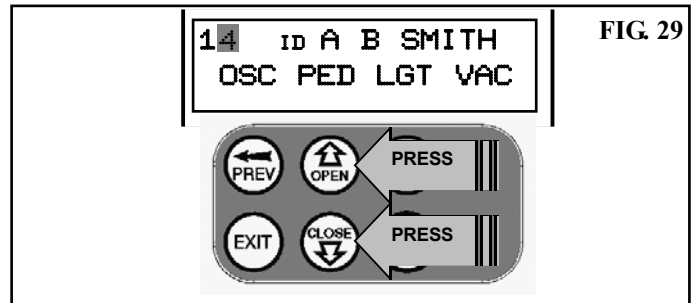
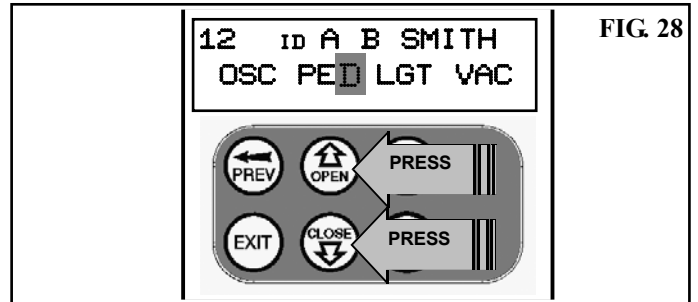

TRANSMITTER MANAGEMENT

The opener provides a transmitter listing facility which enables the user to find a transmitter location within memory. Once located a stored transmitter can be replaced, deleted, edited, copied or, if the location is empty, a new transmitter can be coded.

Method 1 - Go to the Start of the List

STEP 1 ACCESSING THE LIST MENU

1. Press NEXT to navigate to the Menu 1 (Fig. 34).
 2. Press SET to enter the transmitter edit procedure.
 3. Press NEXT to enter transmitter list and edit mode (Fig. 35).
- Used if the transmitter is not available.

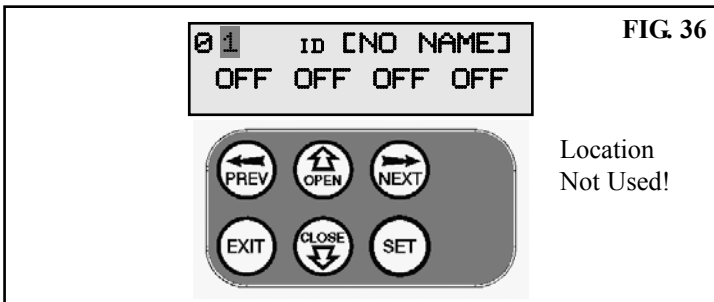
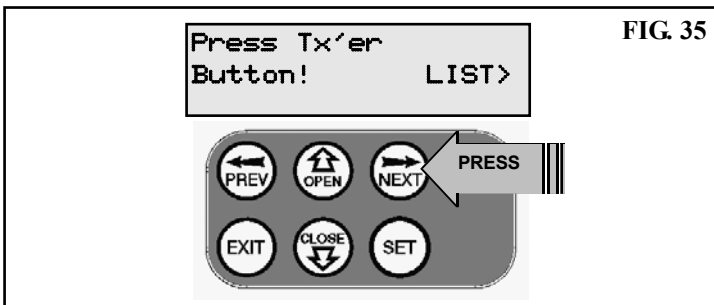
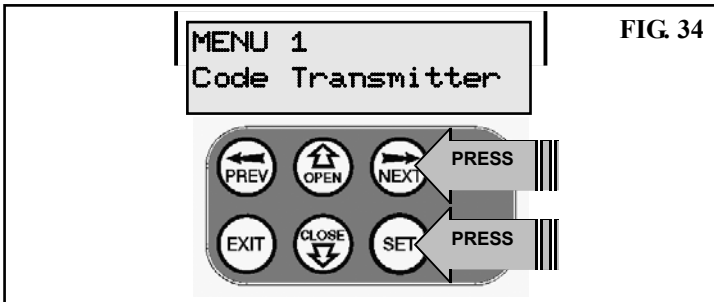

Method 2 - Use Transmitter to go Direct to List

STEP 1 ACCESSING THE LIST MENU

1. Press NEXT to navigate to the Menu 1 (Fig. 37).
 2. Press SET to enter the transmitter edit procedure.
 3. Press transmitter once (Fig. 38).
 4. Press NEXT to view transmitter parameters (Fig. 39).
- Used for quick navigation if the transmitter is available.

Note: "VIEW>" will not be shown if the transmitter is not stored.

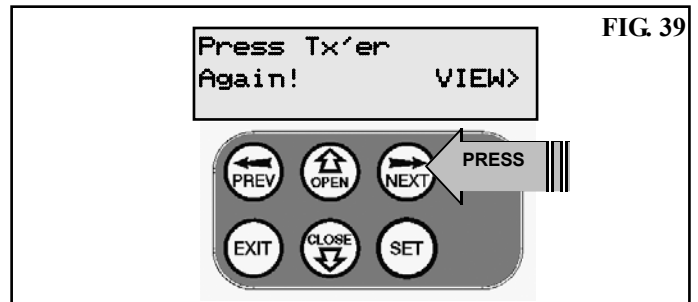
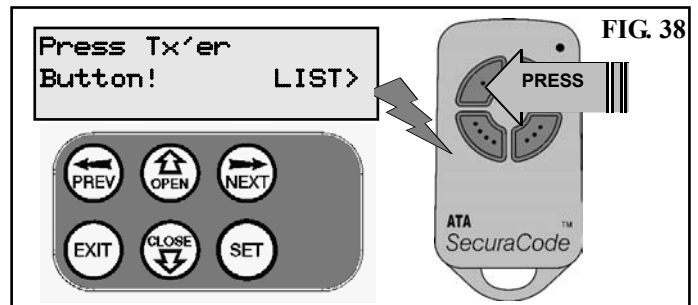
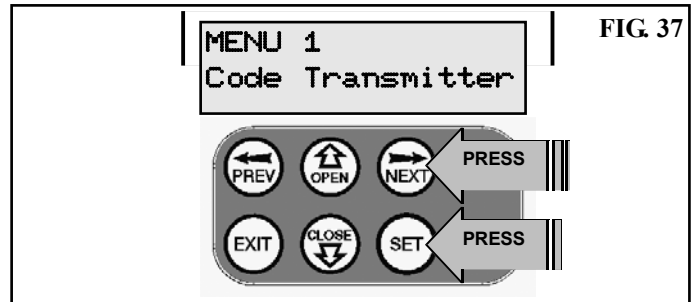

TRANSMITTERS MANAGEMENT

Once the list is displayed it can be sorted by Store number, ID Label or Serial Number. Use NEXT or PREV button to select sorting method.

Note: When sorting by ID label or S/N, only stored transmitters locations are displayed.

STEP 2. NAVIGATING THE LIST

1. Press UP or DOWN buttons to navigate through list (**Fig. 41**).
2. Press SET to display menu of available functions.

Note: Holding a button down will step through the list faster.

SELECTING AN OPERATION

Press NEXT or PREV to cycle through four menu options (**Fig. 42 - 45**). Press EXIT to return to the list. Press SET to execute the menu's operation.

CODE OPERATION (LOCATION EMPTY)

If the code operation is selected on an empty transmitter location, the BASIC CODE TRANSMITTER PROCEDURE will be initiated with the transmitter being saved in the selected location. This is useful when managing transmitters using a scheme which ties the store location to the transmitter's owner.

CODE OPERATION (LOCATION USED)

If the code operation is selected for a location that already contains a transmitter, then the BASIC CODE TRANSMITTER PROCEDURE will be initiated and the new transmitter will replace the existing one. Note that the button functions and name of the existing transmitter will be transferred to the new transmitter. This procedure is of great convenience when replacing a lost transmitter.

DELETE OPERATION

The delete operation is used to remove a transmitter from memory along with the name and button function settings.

EDIT OPERATION

The edit operation displays the transmitter record for editing purposes. See TRANSMITTER EDIT PROCEDURE for details.

COPY OPERATION

The copy operation is used to code multiple transmitters with the same button function as that of the selected transmitter. Once selected an abbreviated code set routine is initiated which repeats steps 2 & 3 of the BASIC CODE TRANSMITTER PROCEDURE for each transmitter to be coded. Coding is terminated by pressing the EXIT button.

EXITING THE LIST

To exit the transmitter list simply press EXIT to return to the Code Transmitter Menu.

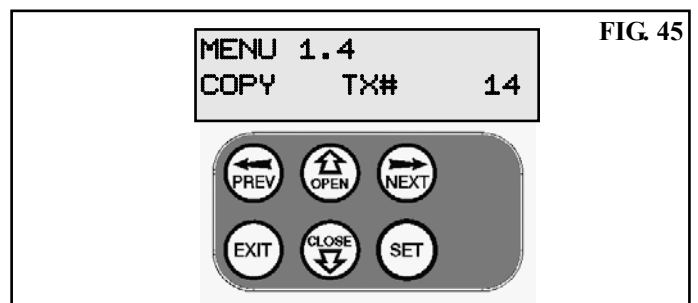
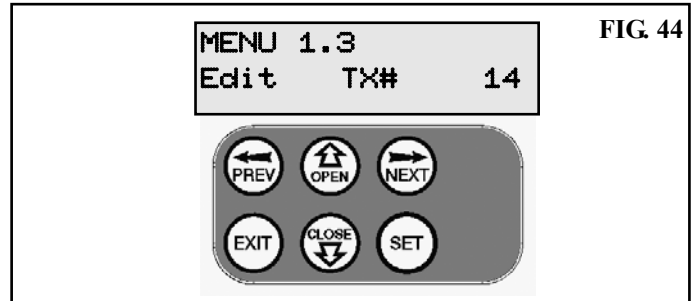
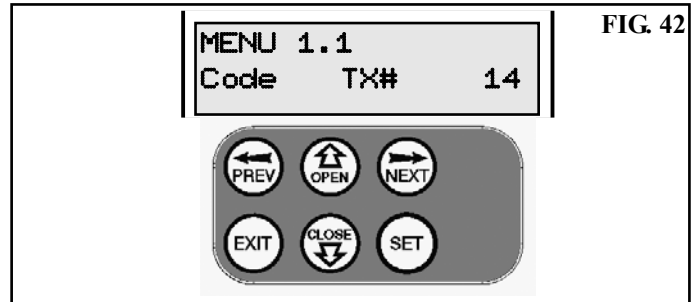
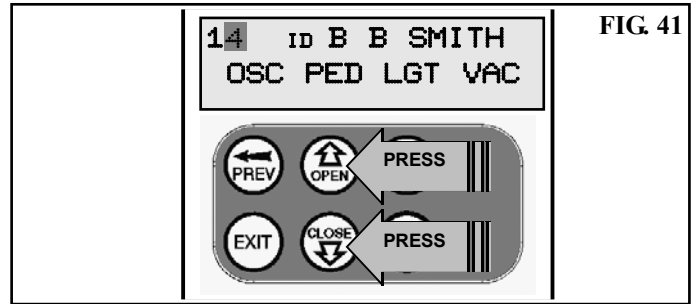

REMOTE CODE SET PROCEDURE

If a transmitter is already coded into the opener, additional transmitters can be coded without being in direct contact with the opener's control panel.

NOTE: Only the function of the existing transmitter button can be assigned to new transmitter. Please read instructions prior to proceeding - there is a time-out facility for security reasons.

1. SELECTING THE FUNCTION TO BE CODED

Using the existing transmitter, operate the gate with the transmitter button which has the function to be coded (**Fig. 46**).

(e.g. Button 1 has been coded with the OSC function assigned).

2. WAIT FOR GATE TO COMPLETE CYCLE

If the button's function activates the gate (PED, SWP, OSC, CLS, STP or OPN) wait for the gate to complete its cycle.

3. ACTIVATE REMOTE CODE SET MODE

Using a small pin press and hold through the Coding Hole of the existing transmitter for two seconds (**Fig. 47**).

4. CODE NEW TRANSMITTER BUTTON

Within 10 seconds, press the button on the new transmitter you wish to code for 2 seconds (**Fig. 49**).

5. CONFIRM TRANSMITTER BUTTON TO BE CODED

Press the same button again (within 10 seconds) for confirmation.

6. TEST OPERATION

The new transmitter button should now function as the existing transmitter.

NOTE: When a transmitter is remote coded, its ID label is set to that of the existing transmitter. If the existing transmitter does not have an ID label assigned, then the ID label of the new transmitter is set to: R/C Tx ###, where ### is the existing transmitters store number. This ensures that the originator of any remote coded transmitter can be identified.

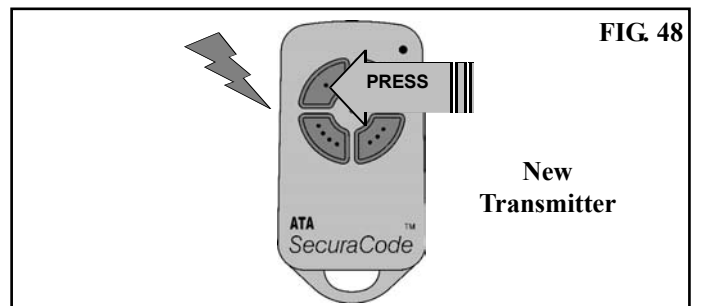
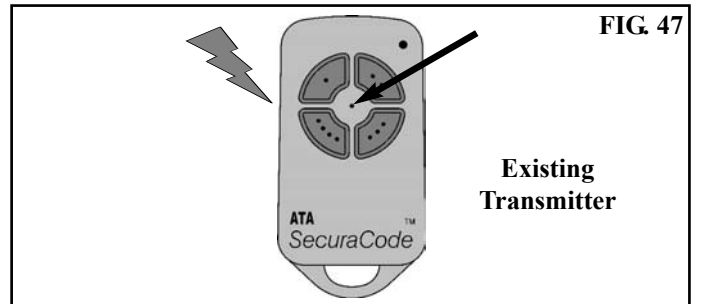
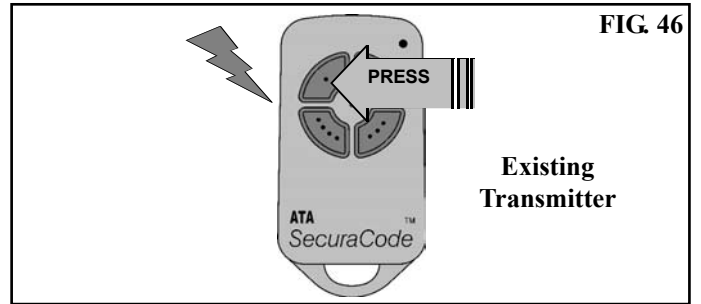

DIAGNOSTIC TOOLS

The controller provides several diagnostic tools from within the diagnostics menu (menu 8) this section details the function of each tool and its use.

NAVIGATING TO DIAGNOSTICS MENU

1. Press PREV to navigate Menu 8 (Fig. 49).
2. Press SET to display menu of available functions.
3. Press PREV or NEXT to cycle through diagnostic tool.
4. Press SET to select.

MENU 8.1 TEST INPUTS

This tool is used to view the state of the control inputs. When selected, a screen is displayed (Fig. 50) which indicates the state of each input. If the name of the input is in uppercase then the input is active, conversely if the input is in lower case then the input is inactive. For normal operation all inputs should be inactive. When finished press EXIT. The example shows the status as OSC input is active.

MENU 8.2 TEST TX'ERS

This tool is used to test receiver/transmitter functionality. When selected, a screen is displayed which prompts for a transmitter button to be pressed (Fig. 51) and whether ID or serial numbers are to be displayed.

The opener will then beep each time a transmission is received. If the transmitter button is stored in the controller memory and has a function assigned to it, a second screen will be displayed that shows the transmitter details along with the button pressed (Fig. 52). The example shows the case when transmitter number 12 is activated by button 4. Note ID is selected for display.

MENU 8.3 DISPLAY HISTORY

The opener keeps a record of the last 64 events that have taken place. The events include the type of drive cycles executed, obstruction detection, various faults, power failures etc. When this tool is selected the screen displays the last event that occurred (Fig. 53). Press NEXT or PREV to view each event. The "EVENT#" field shows the sequence of the events, with (1) being the first and (64) being the last. The example shows that the last event was a close cycle which succeeded in closing the gate. When finished viewing the events, press EXIT.

MENU 8.4 MEMORY USAGE

This tool displays the number of transmitter store location used and the number free (Fig. 54).

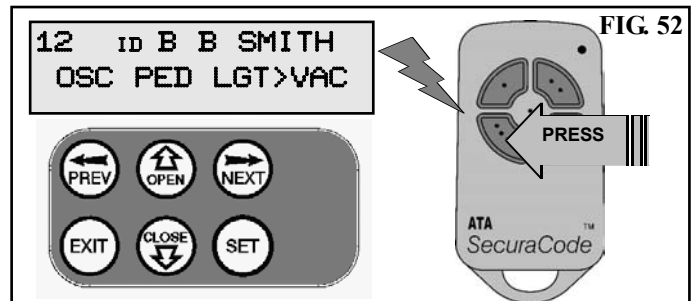
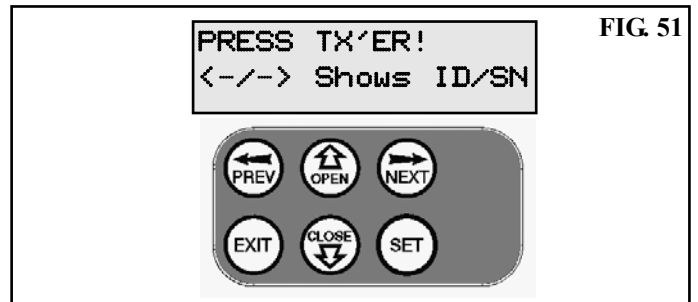
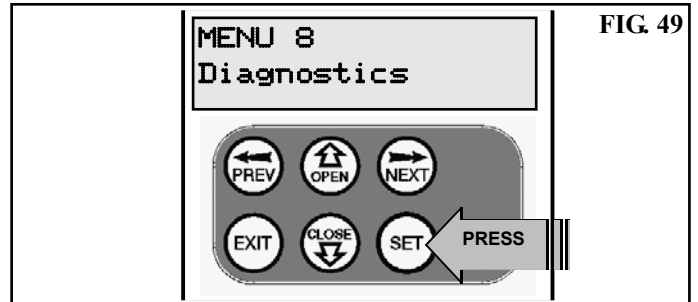

DIAGNOSTIC TOOLS

MENU 8.5 SERVICE COUNTER

The opener provides a periodic service counter which can be set to expire after a number of drive cycles. When expired, the opener will beep at the beginning of each drive cycle and a message will be displayed on the MAIN SCREEN (Fig. 55). This tool displays the current value of the service counter and allows the user to set its value using the normal parameter editing techniques (See PARAMETER VIEWING AND EDITING). If the service counter is not to be used it can be set to the maximum number (60,000)



MENU 8.6 COUNTERS

The opener keeps a count of number of times a particular event occurs. The list of event counters kept is shown below. When this tool is selected the first event counter is shown (Fig. 56). Press NEXT or PREV to step through the list. The example below shows the OPEN CYCLE event counter with a value of 1234. When finished viewing press EXIT.

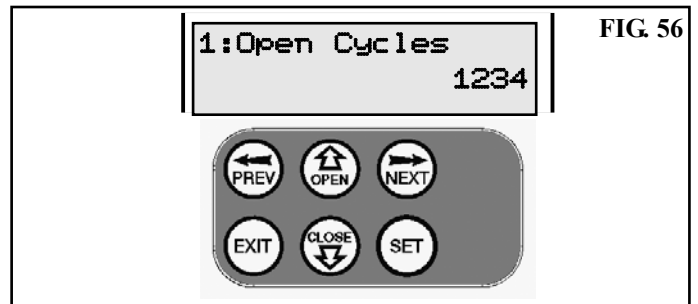

- | | |
|-----------------|-------------------------|
| 1: Open Cycles | 7: Open Obstructions |
| 2: Close Cycles | 8: Close Obstructions |
| 3: Ped Cycles | 9: Open Overloads |
| 4: Setup Limits | 10: Close Overloads |
| 5: Open Stall | 11: Limit Sensor Faults |
| 6: Close Stall | |

MENU 8.7 INSTALLATION

The controller keeps a record of the options selected during installation and also the travel times recorded during installation. The list below shows the information recorded. Use the NEXT and PREV buttons to move through the list. When finished viewing simply press EXIT.

- | | |
|---------------------|-----------------------|
| 1: Open Cycle Time | 3: Motor Encoder Mode |
| 2: Close Cycle Time | 4: Speed Ramping mode |

MEMORY TOOLS

The Memory Tools accessed from within Menu 9 are used to back-up, restore or clear the controller's memory. Once selected the PREV or NEXT buttons can be used to view the Memory Tool options. To Execute the displayed option simply press SET.

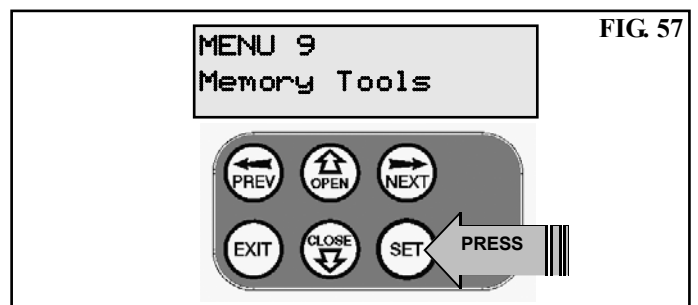

MENU 9.1 CLR CONTROL

This option will clear the gate control memory and reload the factory set defaults for parameters such as the lock time, light time, auto-close times etc. It will also clear the travel limits.

MENU 9.2 CLR TX'ERS

This option will clear the transmitter storage memory.

MENU 9.3 BACKUP TX'ERS

This option saves a copy of the transmitter memory into a memory module connected to the controllers programmer connector.

MENU 9.4 RESTORE TX'ERS

This option will restore the transmitter memory from the inserted memory module.

MENU 9.5 IMPORT LABELS

This option will overwrite the current transmitter labels with those stored in the inserted memory module. This option is provided so that transmitter labels entered using Transmitter Management software on a P.C can be loaded into memory without altering the transmitters themselves.

ACCESSORIES INSTALLATION

This opener does not feature an inherent obstruction detection (reversing) system. For safety a PE Beam MUST be fitted.

FITTING PHOTO ELECTRIC BEAM

Locate the Photo Electric (P.E.) Beam in a strategic location in the gateway. ATA recommend that the sensor is placed 150mm above the floor level and as close as possible to the door opening. Remove the shunt from the P.E. input and connect as per the wiring diagram at right. make sure that the sensors are correctly aligned as per the instruction manual. supplied with the P.E. Beam kit. See Page 14 for set up of Auto-Close times.

Warning: When using Auto-Close mode and P.E. Beams the gateway must be clear of all obstructions and persons at all times. The location of the P.E. Beam and the manner in which it is installed might not give safety protection at all times. Check to make sure that the height of the sensor and type used offers maximum protection possible.

FITTING SOLENOID OR MAGNETIC LOCKS

Install the lock mechanism on the gate as per the manufacturers instructions. The wiring diagram at right is a representation of a typical lock with a bias for normally closed contact.

FITTING COURTESY LIGHTS

An AC or DC courtesy light can be activated via an output on the gate opener control board. Connect the light as per the diagram at right. See Page 15 for Light Times set up.

Warning: A qualified electrician must perform the installation where three phase 415V AC power is used.

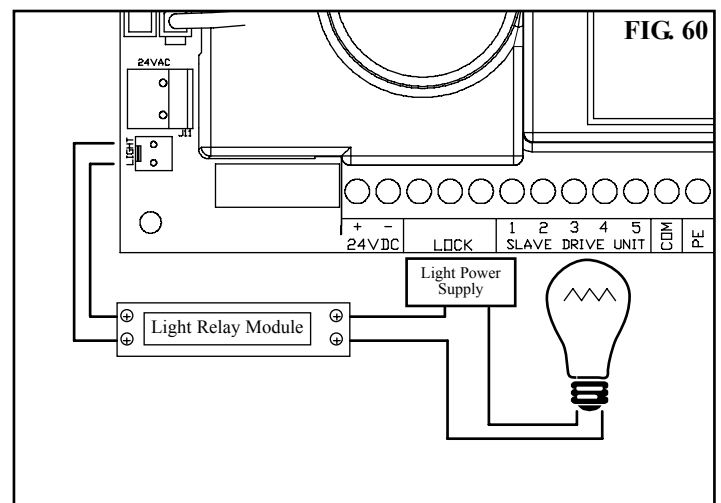
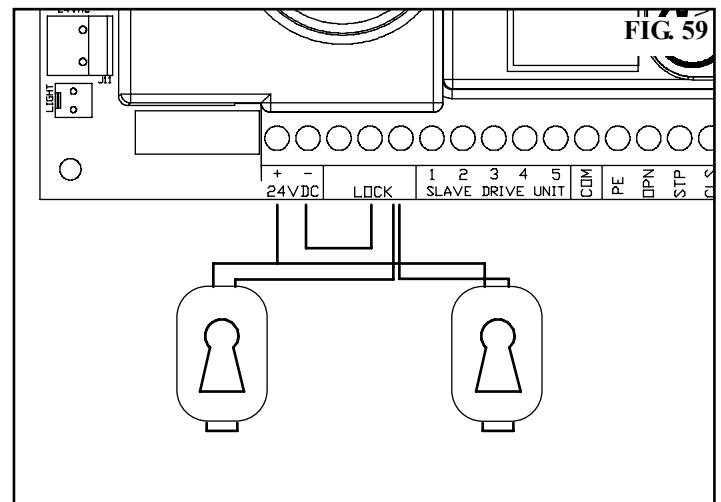
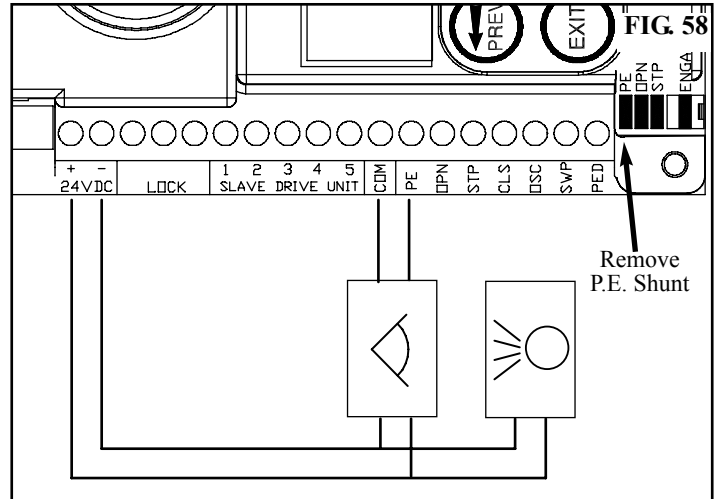

TROUBLE SHOOTING GUIDE

POSSIBLE CAUSE	POSSIBLE CAUSE	REMEDY
Door will not operate.	Mains power not switched on. Door is obstructed. Door is locked or motor jammed. Door tracks/hardware damaged.	Switch on mains power. Remove obstruction. Unlock door or remove jam. Door requires service/repair by qualified technician.
Door does not operate from transmitter. *See note.	Transmitter code not stored in memory. Flat Battery.	Code transmitter in to openers memory. Refer page 18. Replace battery - A23 Alkaline 12V.
Door will not close fully.	Door limits positions need to be reset.	Reset limits positions. Page 10.
Door will not open fully.	Door limits positions need to be reset.	Reset limits positions. Page 10.
Auto close not working.	PE Beam or wiring faulty PE Beam not aligned correctly. PE Beam is obstructed. Door obstructed when closing. Auto close time not set.	Repair PE Beam or replace wiring. Re-align optics. Remove obstruction from the path of PE. Remove obstruction. See page 14.

***Please Note:** Some areas may be prone to excessive radio interference brought on by devices such as cordless telephones, wireless stereo headphones and baby monitors. It is possible that these devices could cause a degree of interference such as to greatly reduce the range of the transmitter. In such an instance please contact your ATA dealer for assistance. As this is not a warrantable situation but an environmental issue charges may apply.

SPECIFICATIONS

TECHNICAL SPECIFICATIONS

INPUT VOLTAGE:	415V AC 50Hz Three Phase
MOTOR TYPE:	Induction
MOTOR VOLTAGE:	415V AC Three Phase
MAXIMUM DOOR SIZE:	25m ²
MAXIMUM DOOR HEIGHT:	3500mm (up to 6000mm)*
RECEIVER TYPE:	UHF 433.92 MHz. AM Receiver
RECEIVER CODE STORAGE CAPACITY:	511 Transmitters
TRANSMITTER FREQUENCY:	433.92 MHz
CODING TYPE:	Hopping Code
No. of CODE COMBINATIONS:	Over 4.29 Billion Random Codes
CODE GENERATION:	Non-linear Encryption Algorithm
TRANSMITTER BATTERY:	A23 Alkaline 12 Volts
DRIVE UNIT WEIGHT:	23Kg

Please Note: Specifications are subject to change without notice.

PARTS LIST

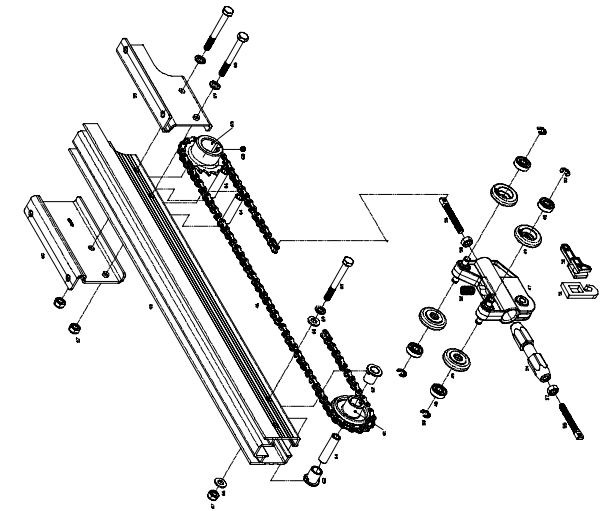

ITEM No.	DESCRIPTION	ORDER CODE
45	TRACK 62x52x3 MM (12020740)	04630
46	CHAIN 1/2"x1/8" (613 LINKS) W/2CL	03003
47	SHUTTLE TROLLEY (12020316-A)	02654
48	BALL BEARING 500-2R51	03962
49	WHEEL (12020390)	16395
50	DIS-ENGAGEMENT ARM (0510591)	02610
51	INDEX FINGER (051061)	02670
52	COMPRESSION SPRING 1.2 (051180)	10815
53	E-CIRCLIP D16x0.0076	02945
54	CHAIN INDEX HEX 18 (12020480)	05780
55	CHAIN SCREW RIGHT (05020120)	05770
56	CHAIN SCREW LEFT (05020130)	10870
57	HEX NUT M8	10920
58	HEX NUT (LEFT HAND) M8	02566
59	BRACKET R/L (12020400)	02505
60	BRACKET L/R (12020380)	13960
61	CHAIN WHEEL 38 (12020436-A)	04701
62	BUSH SLEEVE (050882)	04385
63	SPROCKET 16T/26T (12020241)	11020
64	SLEEVE 16T/26T (12020410)	10088
65	HEX HEAD SCREW M6 X 7.0	10250
66	FLAT WASHER I.D. 8	10090
67	WASHER I.D. 8	10029
68	SOCKET SET SCREW M6 X 1.6	10050
69	SPRING WASHER I.D. 8	10060

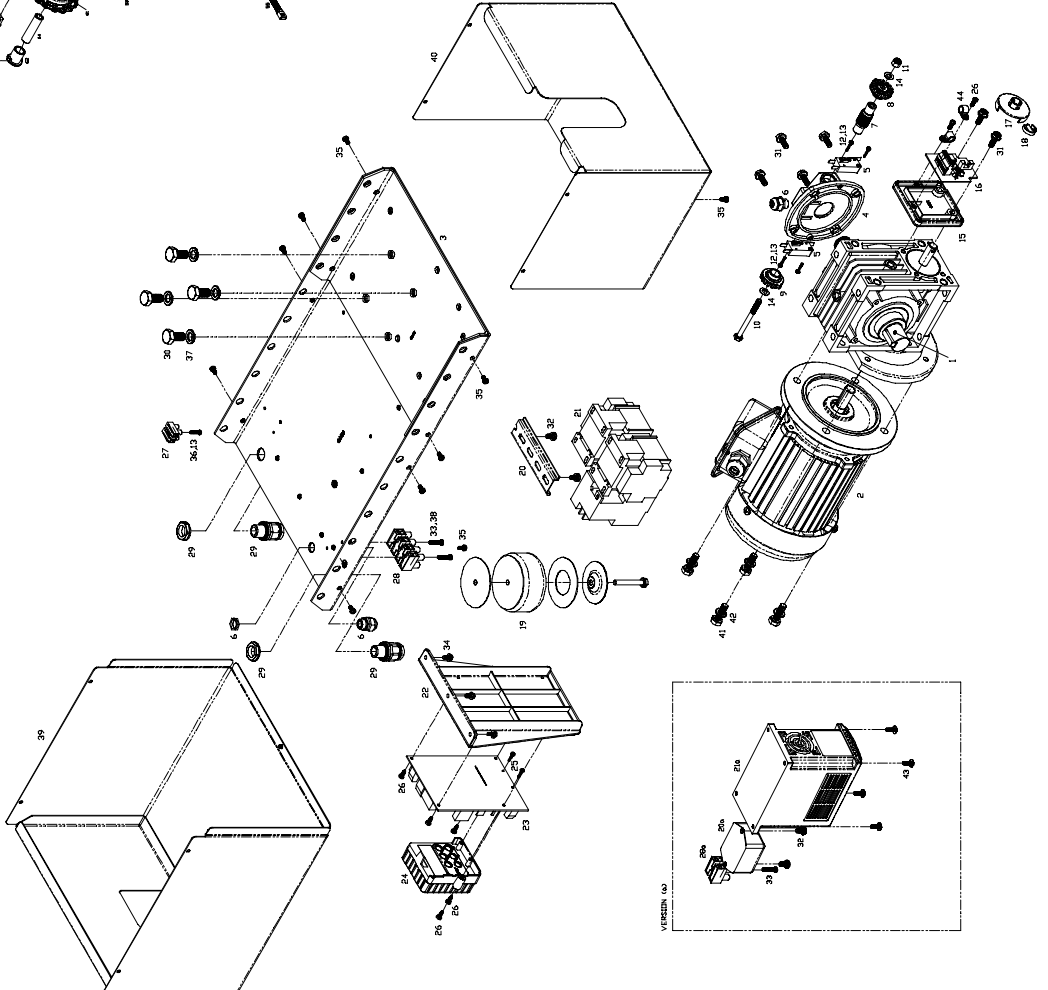

ITEM No.	DESCRIPTION	ORDER CODE
1	REDUCER JANMEN 50 W/ 140	14500
2	AC MOTOR 3/5W 3P 41V DELTA	14511
3	CHASSIS ASSY (12020260)	02775
4	LIMITS HOUSING BASE (12020281)	16270
5	MICROSWITCH LABY (2226)	06282
6	NYLON CABLE GLAND P657-07B	06622
7	HELICAL GEAR 30/95 (12020300)	04044
8	LIMIT CAM RED (12020310)	04912
9	LIMIT CAM GREEN (12020310)	10286
10	HEX HEAD SCREW M6 X 6.5	10961
11	NILLOCK NUT M6	10540
12	TAPTITE SCREW PP/BLACK ZINC M3 X 16	11150
13	INT TOOTH LOCK WASHER I.D. 3	11040
14	FLAT WASHER I.D. 6	16390
15	TACHO BASE (12020370)	01152
16	P.D. ENCODE BOARD PDE-1J4	13026
17	TACHO WHEEL (12020360)	04980
18	CLIPPER CLIP (05040230-B)	02030
19	TRANSFORMER T05-40-11 KIT	92022
20	RAIL DN STEEL	01922
20a	FILTER CNISC	92431
21	CONTRACTORS ASSY TORR1 3-1.415V	01950
21b	INVERTOR F100	14014
22	CB-14 SUPPORT (12020390-A)	01050
23	CONTROL BOARD CB-14-V1.02	92578
24	COVER ASSY CB-14 (12020121)	10553
25	TAPTITE SCREW PP/BLACK ZINC M3 X 12	10570
26	TAPTITE SCREW PP M4 X 10	05421
27	TERMINAL BLOCK 500/20DS 2 POS	05426
28	TERMINAL BLOCK 500/02	05425
28a	TERMINAL BLOCK 500-02	06620
29	NYLON CABLE GLAND K16 (M18-10B)	10065
30	HEX HEAD SCREW M10 X 20	10370
31	HEX SEPARATION HEAD SCREW M8 X 16	10281
32	PAN-10 SCREW/WASHER M5 X 10	10940
33	PAN-10 SCREW M4 X 16	10940
34	PAN-10 SCREW/WASHER M4 X 10	10920
35	PAN-10 SCREW/WASHER M4 X 8	10960
36	PAN-10 SCREW M3 X 14	10940
37	SPRING WASHER I.D. 10	11140
38	INT TOOTH LOCK WASHER I.D. 4	02760
39	BACK COVER ASSY (12020201)	02765
40	FRONT COVER ASSY (12020211)	10110
41	HEX HEAD SCREW M8 X 25	10840
42	SPRING WASHER I.D. 8	10381
43	SER HEAD SCREW/WASHER M4 X 12	11750
44	CABLE CLAMP ACC-1.5 (8/16")	

WHEN ORDERING SPARE PARTS
PLEASE QUOTE THE ORDER
CODE NUMBER TO YOUR
INSTALLER/DISTRIBUTOR

WARRANTY AND EXCLUSION OF LIABILITY

1. This warranty is an addition to any non-excludable conditions or warranties that are implied into this contract by relevant statute, including the Trade Practices Act 1974 (Cth).
2. Subject to all of the matters set out below, Automatic Technology Australia Pty Ltd ("ATA") warrants:
 - (a) the Axess Pro Series Opener for twelve (12) months,
 - (b) all components and accessories for twelve (12) months, from the date of purchase (specified in the sales docket receipt) as free of any defects in material and workmanship.
3. This warranty applies only where the purchaser:
 - (a) immediately notifies ATA or the retailer of the alleged defect;
 - (b) returns the product to the retailer; and
 - (c) presents the relevant sales docket and this warranty document to the retailer to confirm the date of purchase.
4. Except for this warranty, ATA gives no warranties of any kind whatsoever (whether express or implied), in relation to the product, and all warranties of whatsoever kind relating to the product are, to the extent permissible by statute, hereby excluded.
5. To the extent permissible by statute, ATA disclaims any liability of whatsoever nature in respect of any claim or demand for loss or damage which arises out of:
 - a) accidental damage to or normal wear and tear to the product or to the product's components;
 - b) any cost relating to damage resulting from wear and tear;
 - c) blown fuses, loss or damage caused by electrical surges, power surges or power spikes;
 - d) loss or damage due to theft, fire, flood, rain, water, lightning, storms or any other acts of God;
 - g) door surface area exceeding 25m²;
 - h) door not in safe and correct working order and condition;
 - i) evidence of unauthorised repairs;
 - j) any cost relating to damage caused by misuse, negligence or failure to maintain the equipment in a proper working order as per clauses (d) through (i);
 - k) installation, adjustment or use which is not in accordance with the instructions set out in installation instruction manual;
 - l) attempted or complete modification or repairs to the product carried out by a person who is not authorised or has not been trained by ATA to carry out such modification or repairs;
 - m) faulty or unsuitable wiring of structure to which the product is fixed or connected;
 - n) radio (including citizen band transmission) or any electrical interference;
 - o) damage caused by insects;
 - p) loss or damage to any property whatsoever or any loss or expense whatsoever resulting or arising there from or any consequential loss;
 - q) any cost or expense arising due to manufacturer recall of any product;
 - r) any cost or expense due to negligence of the approved service provider;
6. ATA's liability under this warranty is limited, at ATA's absolute option, to replacing or repairing the product which ATA, in its unfettered opinion, considers to be defective either in material and/or workmanship or to credit the dealer with the price at which the product was purchased by the dealer.
7. This warranty does not extend to cover labour for installation.
8. This warranty is limited to Return-to-Base (RTB) repair and does not cover labour for on-site attendance.
9. This warranty is void if the Product is not returned to the manufacturer in original or suitably secure packaging.
10. This warranty is only applicable for repairs to the product carried out within Australia.
11. This warranty does not cover consumable items including globes, batteries and fuses.
12. This warranty is not transferable.
13. This warranty is void if a Photo Electric Beam Sensor is not fitted to the door opening.
14. Where the Product is retailed by any person other than ATA, except for the warranty set out above, such person has no authority from ATA to give any warranty or guarantee on ATA's behalf in addition to the warranty set out above.

Notes:

1. One (1) cycle = one (1) open and one (1) close action of the door.
2. This warranty is to be read in conjunction with the owner's copy of the installation instruction manual.

AUTOMATIC TECHNOLOGY AUSTRALIA PTY LTD

ABN 11 007 125 368

17-19 Advantage Rd, Highett, Victoria, Australia 3190

Tel: +61 3 9532 2788 Fax: +61 3 9532 2799

Web: www.ata-aust.com.au Email: sales@ata-aust.com.au