

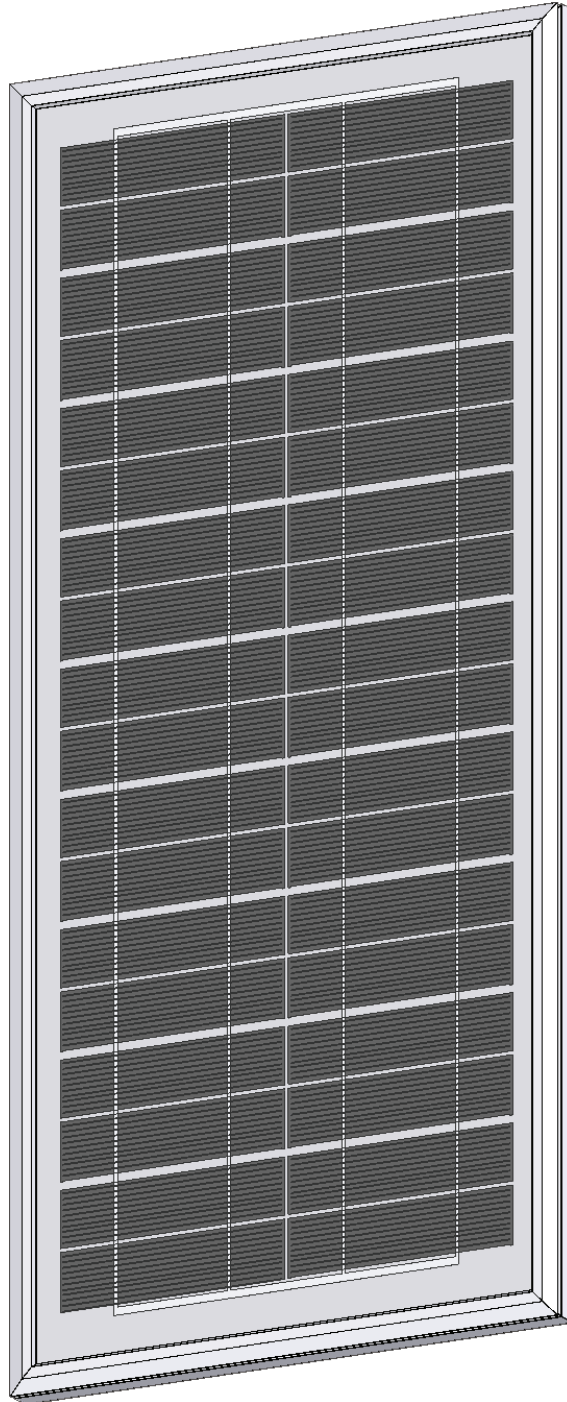

SmartSolar™

Solar Power Kits For Automatic Technology Openers



automatic
TECHNOLOGY

SmartPlanet™
Solutions



WARNING: It is vital for the safety of all persons to follow these instructions. Failure to comply with the installation instructions and safety warnings may result in serious personal injury and/or property damage. Please save these instructions for future reference.

Automatic Technology (Australia) Pty Ltd to the extent that such may be lawfully excluded hereby expressly disclaims all conditions or warranties, statutory or otherwise which may be implied by laws as conditions or warranties of purchase of an Automatic Technology (Australia) Pty Ltd Product. Automatic Technology (Australia) Pty Ltd hereby further expressly excludes all or any liability for any injury, damage, cost, expense or claim whatsoever suffered by any person as a result whether directly or indirectly from failure to install the Automatic Technology (Australia) Pty Ltd Product in accordance with these installation instructions.



SmartSolar™

Solar Power Kits For Automatic Technology Openers

Important Safety Instructions	4
SmartSolar™ Features	5
Package Contents	6
Charger Board Layout	6
Installing the Solar Panel	8
Swing Gate Opener Set Up	9
Sliding Gate Opener Set Up	10
Overhead Door Opener Set Up	11
Roll Up Door Opener Set Up (GDO-6 EasyRoller®)	12
Roll Up Door Opener Set Up (GDO-8 EasyRoller®)	13
Specifications	14
Warranty	15





Important Safety Instructions

WARNING: It is vital for the safety of all persons to follow these instructions. Failure to comply with the following safety rules may result in serious personal injury and/or property damage.

DO NOT short the output of batteries. **Serious personal injury** and/or property damage can result from failure to follow this warning.

DO NOT connect battery wires incorrectly to solar charger - **Observe the polarity carefully!**

DO NOT connect any other source of power to the opener if a SmartSolar™ kit is installed.

DO NOT use the SmartSolar™ kit to power other devices - it is specifically designed for Automatic Technology door and gate openers and some accessories only.

DO NOT handle damaged or leaking batteries.

DO NOT connect the battery box directly to solar panel.

DO NOT bend or drop the solar panel.

The solar charger and battery box unit should be installed away from sprinkler systems.

DO NOT immerse in water or spray directly with a hose or other device.

Install the solar charger kit in a location where it is out of reach of children.

The solar charger kit contains sealed lead-acid batteries that must be disposed of properly at the end of their useful life.

During charging and discharging cycles the lead-acid batteries may release explosive gases. Ensure that the area around the batteries is well ventilated.

Take care not to allow any metal objects to make contact with the positive and negative terminals. This will short circuit the battery causing sparks and possible damage to the battery, the solar charger module, or even cause an explosion.

Wear appropriate protective clothing and avoid touching your eyes after working with batteries.

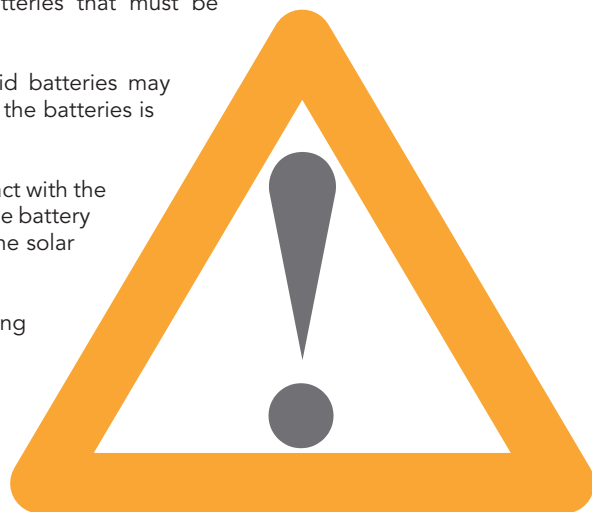



SmartSolar™ Features

Thank you for purchasing the **SmartSolar™** solar power kit for Automatic Technology opener products. The unique and exciting new technologies of SmartSolar™ makes cost effective green or remote location automation a reality. Using only quality components and materials, this product will provide years of smart, simple and secure operation.

- Rugged 100% solid state circuitry, with a low component count, for robust operation and reliability
- Compatible with most DC powered Automatic Technology openers
- The only modification for use is removal of the opener's mains transformer
- The specially designed charger module needs only a single solar panel to charge dual 12Vd.c. batteries
- As little as four hours of sunlight provides enough charge for normal residential operation
- The battery holds enough charge for night time operation, and up to three days of backup power
- Fully weather-sealed components
- Accessories such as P.E. Beams can be integrated with the opener for improved safety or convenience
- The charger module has an integrated diode to prevent reverse current
- The charger module will not overcharge the batteries, and, to extend the life of batteries, the unit will shut down if the batteries' voltage drops below 19V
- Batteries are charged with a maximum of one ampere to prevent overheating
- The SmartSolar™ comes with sealed, non-spill lead acid batteries
- A limiting system only allows a "trickle" voltage to be fed to the batteries when at full charge



SmartPlanet™
Solutions

SmartSolar™ kits are part of Automatic Technology's SmartPlanet Solutions™ - our latest innovations that make environmentally conscious automation a possibility!





Package Contents

fig 01

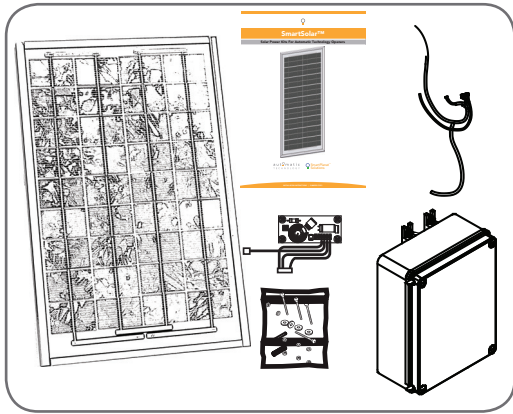

SmartSolar™ Kit (Fig. 01)

Solar Panel - 30 Watt STP030-12/Lb	1
Battery Pack (2 X 12Ah)	1
Charger Board (with harness)	1
2.5 meter two core cable	1
Accessory pack	1
Instruction & Installation Manual	1

Charger Board Layout

- 01 - **SOLAR -** is used to connect (-) from solar panel to this charger board. Connect the **black wire** from solar panel to this connector
- 02 **SOLAR +** is used to connect (+) from solar panel to this charger board. Connect the **red wire** from solar panel to this connector
- 03 - **BAT -** connects the (-) from the battery box to the charger board. Connect the **black wire** from battery box to the connector
- 04 **BAT+** connects the (+) from the battery box to the charger board. Connect the **red wire** from battery box to the connector
- 05 **Red wire** from solar harness connects to this terminal input.
- 06 **White wire** from solar harness connects to this terminal input.
- 07 **Yellow wire** from solar harness connects to this terminal input.
- 08 **Black wire** from solar harness connects to this terminal input.
- 09 **J4 Connector 20watt jumper** this jumper has to be on both pins of j4 connector for 20watt solar panel and must be removed for 30 watt solar panel.
- 10 **J5 Connector 30watt jumper** this jumper has to be on both pins of j5 connector for 30watt solar panel and must be removed for 20 watt solar panel.





Charger Board Layout

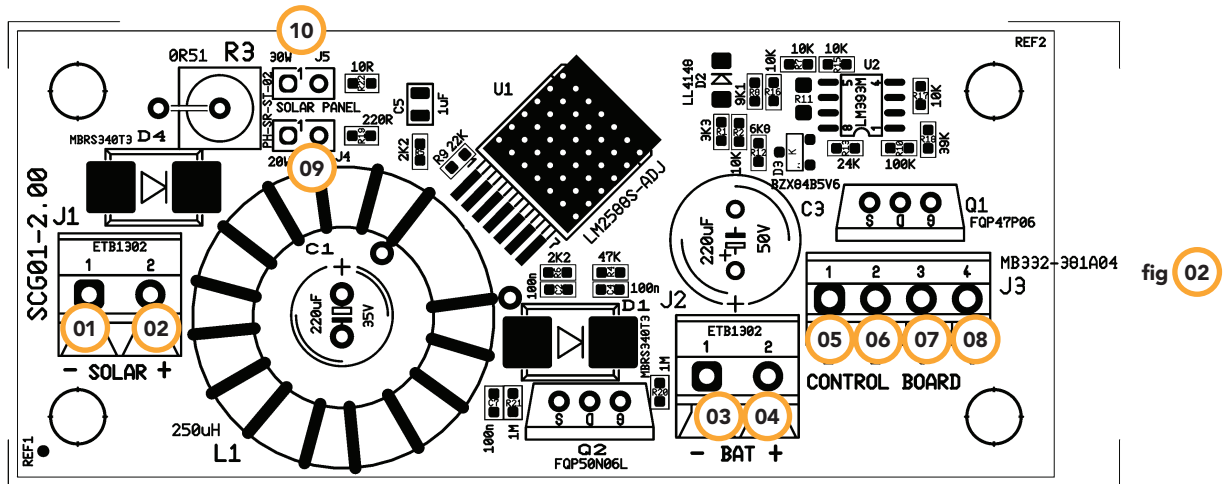

Charger Board Setup

J4 Connector 20watt jumper this jumper has to be on both pins of j4 connector for 20watt solar panel and must be removed for 30 watt solar panel.

J5 Connector 30watt jumper this jumper has to be on both pins of j5 connector for 30watt solar panel and must be removed for 20 watt solar panel.





Installing the Solar Panel

Fig 03

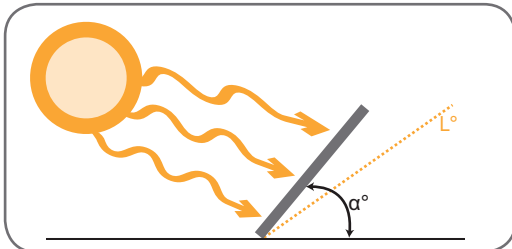

Fig 04

Town	Latitude (L°)	Panel Angle (α°)
Hobart	42.5° S	57.5°
Melbourne	37.5° S	52.5°
Canberra, Adelaide, Albany,	35° S	50°
Sydney	33.5° S	48.5°
Newcastle, Broken Hill, Port Augusta, Perth	32.5° S	47.5°
Brisbane, Oodnadatta, Geraldton	27.5° S	42.5°
Townsville, Tennant Creek, Port Herald	20° S	35°
Darwin	5°	20°

Step 1 - Unpack the Kit

Unpack the Battery Box and the Solar Panel and inspect them for any damage in transit.

Step 2 - Mount the Solar Panel

- Determine a mounting point for the solar panel as close as possible to the intended opener. The length of cable from solar panel to solar charger must not exceed 5m.
- The solar panel should be faced to the North for maximum effect.
 - Solar panel output is directly proportional to the amount of sunlight to which it is exposed. Thus, the panel should be positioned to the north due to Australia's southern location.
- The angle to tilt the solar panel for maximum exposure to the sun is determined by the following equation (Fig. 05):

$$\alpha^\circ = L^\circ + 15^\circ$$

Where "α°" is panel's tilt angle from the horizontal, and "L°" is the latitude of the mounting location. See Fig.04 for a list of pre-calculated panel angles for major centres in Australia

Step 3 - Determine the Type of Opener

- If connecting to a **swing gate opener**, proceed to **page 9**
- If connecting to a **EasySlider® sliding gate opener**, proceed to **Page 10**
- If connecting to a **GDO-9 SecuraLift® overhead door opener**, proceed to **Page 11**
- If connecting to a **GDO-6 EasyRoller® roll up door opener**, proceed to **Page 12**
- If connecting to a **GDO-8 EasyRoller® roll up door opener**, proceed to **Page 12**

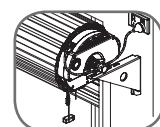
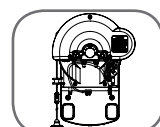



Swing Gate Opener Set Up

SGO-1 Elite™, SGO-4 SecureSwing™ & SGO-4 SecureSwing S™

WARNING: Do not connect the batteries until Step A5 is completed.

Step A4 - Mount the Charger Board

1. Unplug the Control Box from mains power.
2. Remove the Control Box's cover, then remove the transformer, EMC board (if fitted) and mains power cable.
3. Mount the Charger Board on the Control Box's base using four brass spacers and four (4) M4x8 screws (Fig. 05).
4. Plug the Charger Board's three wire harness (red/yellow/black) into the DCB-05 board's "SBY-3" connector (Fig. 06).
5. Plug the Charger Board's one wire harness (white) into the "24vac in" connector on DCB-05 control board (Fig. 06).

IMPORTANT WARNING: Do not connect battery or solar panel polarity incorrectly - this will result in serious damage to components.

Step A5 - Connect the Solar Panel

1. Feed the Solar Panel's cable through the Control Box's grommet
2. Connect the **red wire** to the Charger Board's "SOLAR+" connector, and the **black wire** to the "-SOLAR" connector (Fig. 07).

WARNING: During Step A6 the opener will become active.

Step A6 - Mount & Connect the Battery

1. Mount the Battery Box close to the opener.
2. Feed the 2-core 18awg gauge cable (supplied) through the Battery Box's grommet.
3. Connect the **red wire** to the Battery Box's "+" terminal, and the **black wire** to the "-" terminal (Fig. 8).
4. Feed the other end of the battery cable through the Control Box's grommet.
5. Connect the **red wire** to the Charger Board's "BAT+" connector, and the **black wire** to the "-BAT" connector (Fig. 07).

Step A7 - Re-setup and Test the Opener

1. Select Menu 7 on the DCB-05 control board, press "SET", select Sub Menu 7 ("Battery/Solar") and enable using the "OPEN" and "CLOSE" buttons.
2. Setup travel limits and transmitters as per the DCB-05 instruction manual.
3. Press either "OPEN" or "CLOSE" buttons, or use a transmitter to operate the gate.
4. Refit the Control Box's cover.

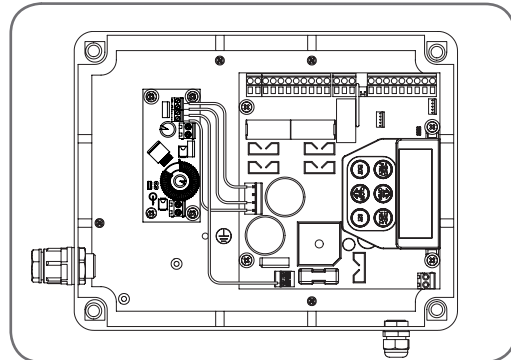

Fig 05

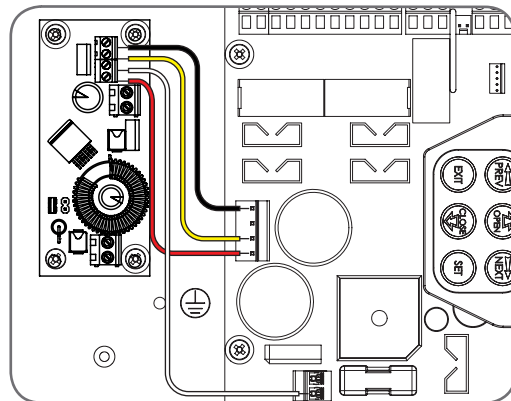

Fig 06

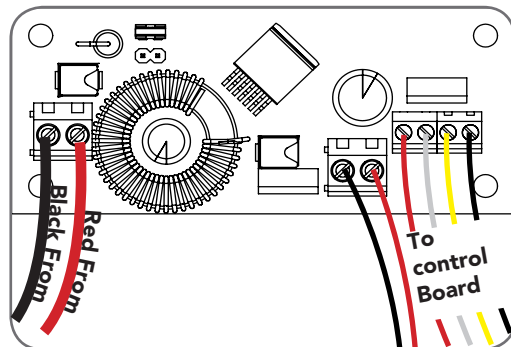

Fig 07

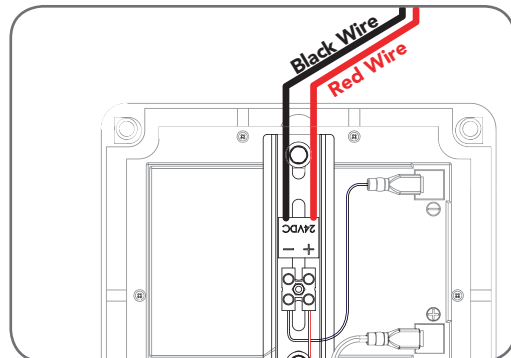

Fig 08





Sliding Gate Opener Set Up

ESV-24 EasySlider® & ESV-24MS EasySlider®

Fig 09

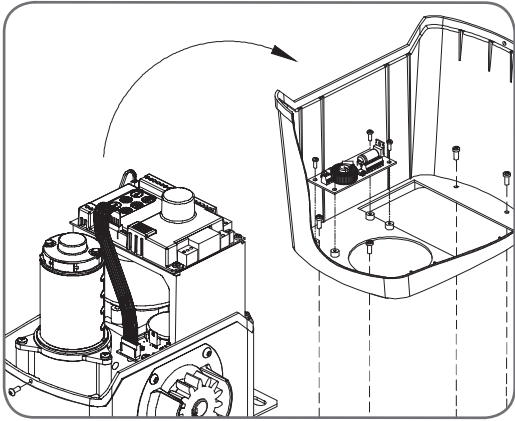

Fig 10

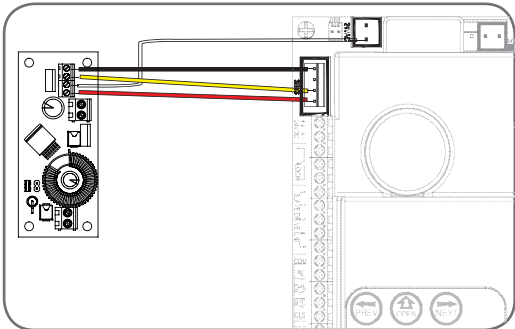

Fig 11

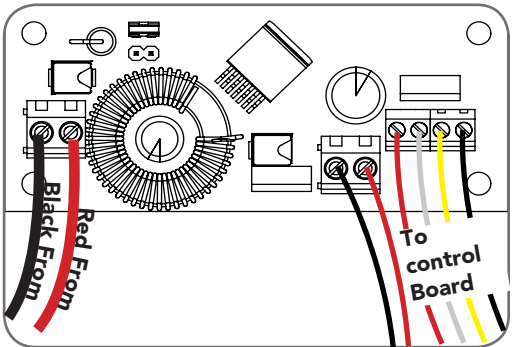
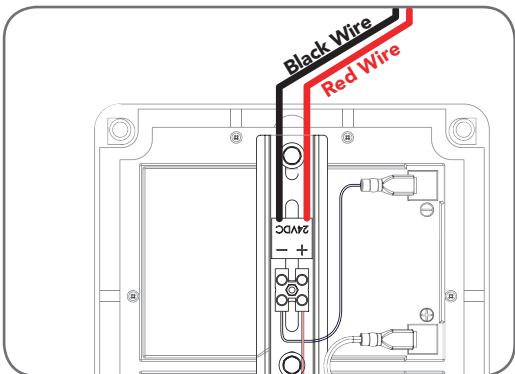

Fig 12



PLEASE NOTE: CB-11 firmware must be v0.65 or higher for SmartSolar™ compatibility

WARNING: Do not connect the batteries until Step B5 is completed.

Step B4 - Mount the Charger Board

1. Unplug the drive unit from mains power.
2. Remove the main cover, then remove the transformer, EMC board (if fitted) and mains power cable.
3. Mount the Charger Board inside the cover using four (4) M4x8 screws (Fig. 09).
4. Plug the Charger Board's three wire harness (red/yellow/black) into the CB-11 board's "SBY-3" connector (Fig. 10).
5. Plug the Charger Board's one wire harness (white) into the "24vac in" connector on CB-19 control board (Fig. 10).

IMPORTANT WARNING: Do not connect battery or solar panel polarity incorrectly - this will result in serious damage to components.

Step B5 - Connect the Solar Panel

1. Feed the Solar Panel's cable through black grommet which the mains power cord ran through
2. Connect the **red wire** to the Charger Board's "SOLAR+" connector, and the **black wire** to the "-SOLAR" connector (Fig. 11).

WARNING: During Step B6 the opener will become active.

Step B6 - Mount & Connect the Battery

1. Mount the Battery Box close to the opener.
2. Feed the 2-core 18awg gauge cable (supplied) through the Battery Box's grommet.
3. Connect the **red wire** to the Battery Box's "+" terminal, and the **black wire** to the "-" terminal (Fig. 12).
4. Feed the other end of the battery cable through the drive unit's black grommet.
5. Connect the **red wire** to the Charger Board's "BAT+" connector, and the **black wire** to the "-BAT" connector (Fig. 11).

Step B7 - Re-setup and Test the Opener

1. Select Menu 7 on the control board, press "SET", select Sub Menu 7 ("Battery/Solar") and enable using the "OPEN" and "CLOSE" buttons.
2. Setup travel limits and transmitters as per the slider instruction manual.
3. Press either "OPEN" or "CLOSE" buttons, or use a transmitter to operate the gate.
4. Refit the Control Box's cover.





Overhead Door Opener Set Up

GDO-9 SecuraLift®

PLEASE NOTE: Control board firmware must be v1.32 or higher for SmartSolar™ compatibility

WARNING: Do not connect the batteries until Step C5 is completed.

Step C4 - Mount the Charger Board

1. Unplug the drive unit from mains power.
2. Remove the screws and swing open the main cover and remove the light diffuser.
3. Remove the transformer, EMC board (if fitted) and mains power cable.
4. Fix the Charger Board under the timing assembly using three (3) M4x8 screws (Fig. 13).
5. Plug the Charger Board's three wire harness (red/yellow/black) into the control board's "SBY-3" connector (Fig. 14).
6. Plug the Charger Board's one wire harness (white) into the control board's "24vac in" connector on (Fig. 14).
7. Plug the solar shunt (supplied) onto the control board's "J13" connector (Fig. 14)

IMPORTANT WARNING: Do not connect battery or solar panel polarity incorrectly - this will result in serious damage to components.

Step C5 - Connect the Solar Panel

1. Feed the Solar Panel's cable through black grommet located on the top of the plastic drive unit cover.
2. Connect the **red wire** to the Charger Board's "**SOLAR+**" connector, and the **black wire** to the "**-SOLAR**" connector (Fig. 15).

WARNING: During Step C6 the opener will become active.

Step C6 - Mount & Connect the Battery

1. Mount the Battery Box close to the opener.
2. Feed the 2-core 18awg gauge cable (supplied) through the Battery Box's grommet.
3. Connect the **red wire** to the Battery Box's "+" terminal, and the **black wire** to the "-" terminal (Fig. 16).
4. Feed the other end of the battery cable through the drive unit's black grommet.
5. Connect the **red wire** to the Charger Board's "**BAT+**" connector, and the **black wire** to the "**-BAT**" connector (Fig. 15).
6. Refit the light diffuser and main cover.

Step C7 - Re-setup and Test the Opener

1. Setup travel limits and code transmitters as per the GDO-9 instruction manual.
2. Press either the "OSC" buttons, or use a transmitter to operate the opener.

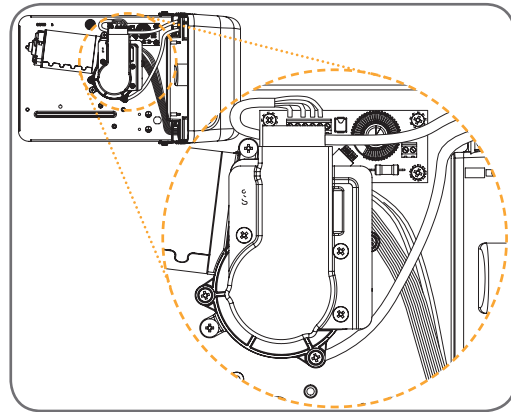

Fig 13

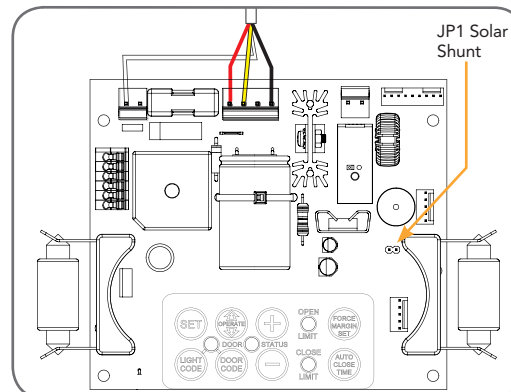

Fig 14

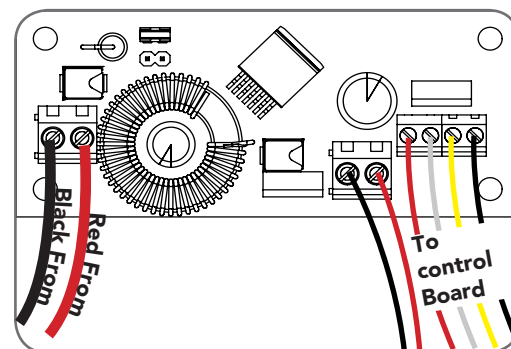

Fig 15

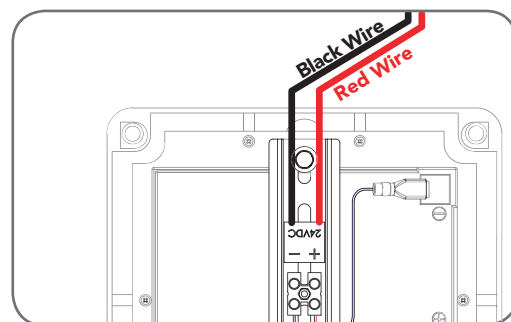

Fig 16





Roll Up Door Opener Set Up

GDO-6 EasyRoller®

Fig 17

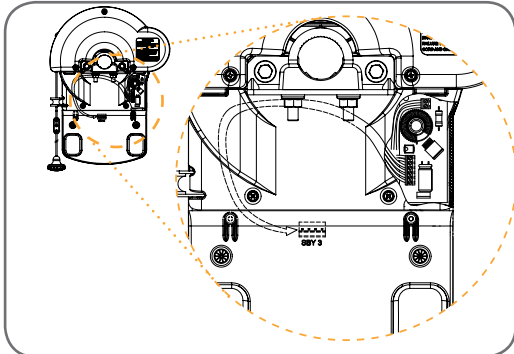

Fig 18

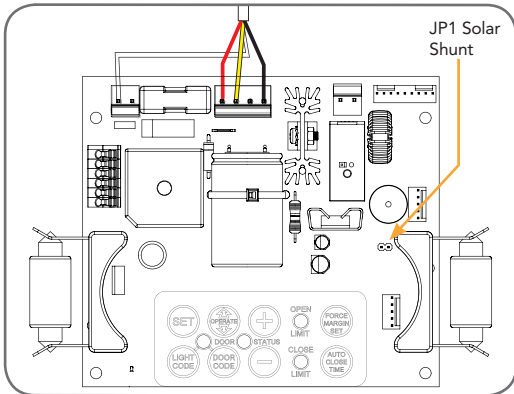

Fig 19

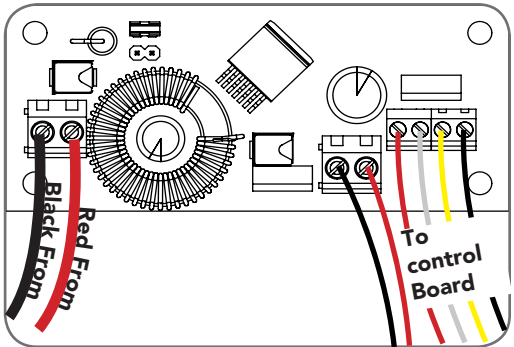
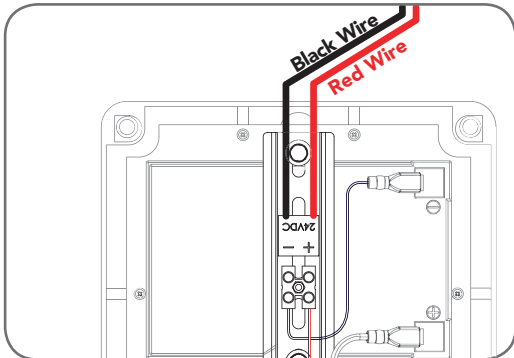

Fig 20



WARNING: Do not connect the batteries until Step D5 is completed.

Step D4 - Mount the Charger Board

1. Unplug the drive unit from mains power.
2. Disengage motor using manual release cord.
3. Remove the main cover, timing cover and light diffuser, then remove the transformer, EMC board and mains power cable.
4. Fix the Charger Board under the timing cover using four (4) M4x8 screws (Fig. 17).
5. Feed the four wire cable through the opening, then connect the three wire harness (red/yellow/black) into the control board's "SBY-3" connector (Fig. 18).
6. Plug the one wire harness (white) into the control board's "24vac in" connector on (Fig. 18).
7. Plug the solar shunt (supplied) onto the control board's "J13" connector (Fig. 18)

IMPORTANT WARNING: Do not connect battery or solar panel polarity incorrectly - this will result in serious damage to components.

Step D5 - Connect the Solar Panel

1. Feed the Solar Panel's cable through black grommet on the chassis.
2. Connect the **red wire** to the Charger Board's "**SOLAR+**" connector, and the **black wire** to the "**-SOLAR**" connector (Fig. 19).

WARNING: During Step D6 the opener will become active.

Step D6 - Mount & Connect the Battery

1. Mount the Battery Box close to the opener.
2. Feed the 2-core 18awg gauge cable (supplied) through the Battery Box's grommet.
3. Connect the **red wire** to the Battery Box's "+" terminal, and the **black wire** to the "-" terminal (Fig. 20).
4. Feed the other end of the battery cable through the drive unit's black grommet.
5. Connect the **red wire** to the Charger Board's "**BAT+**" connector, and the **black wire** to the "**-BAT**" connector (Fig. 19).
6. Refit the timing cover, main cover and light diffuser.

Step D7 - Re-setup and Test the Opener

1. Setup travel limits and code transmitters as per the GDO-6 instruction manual.
2. Press either the "OSC" buttons, or use a transmitter to operate the opener.





Roll Up Door Opener Set Up

GDO-8 EasyRoller®

Step E4 - Insert the Solar Panel's Wires

1. Unplug the drive unit from mains power.
2. Remove the controls cover and chassis enclosure, then remove the transformer and EMC board.
3. Remove the mains power cable, then fit a rubber gland to its hole in the chassis. Feed the Solar Panel's wires through this gland (Fig. 21).
4. Fill the transformer's screw hole by using the rubber washer, metal washer and M6x10 screw (supplied).

 **WARNING:** Do not connect the batteries until Step E5 is completed.

Step E5 - Mount the Battery Box

1. Drill a 12.5mm hole in the chassis enclosure at the location shown in (Fig. 22).
2. Fit a rubber gland to this hole.
3. Mount the Battery Box close to the opener.
4. Feed the 2-core 18awg gauge cable (supplied) through the Battery Box's grommet, and the 12.5mm hole in the opener's chassis.
5. **DO NOT CONNECT THE WIRES** to the Charger Board or battery terminals.

 **IMPORTANT WARNING:** Do not connect battery or solar panel polarity incorrectly - this will result in serious damage to components.

 **WARNING:** During Step E6 the opener will become active.

Step E6 - Mount & Wire the Charger Board

1. Secure the adhesive mounts to the Charger Board with cable ties. Affix the Charger Board inside the chassis enclosure above the 12.5mm drilled hole.
2. Unscrew and remove the four-wire harness from the Charger Board. Replace with the two-wire (red/yellow) harness, connecting wires as shown (Fig. 23).
3. Plug the two wire (red/yellow) harness into the control board's "24vac supply" connector.
4. Connect the **red wire** to the Charger Board's "**SOLAR+**" connector, and the **black wire** to the "**-SOLAR**" connector (Fig. 23).
5. Connect the **red wire** to the Battery Box's "**+**" terminal, and the **black wire** to the "**-**" terminal (Fig. 24).
6. Refit covers and chassis enclosures to the opener.

Step E7 - Re-setup and Test the Opener

1. Setup travel limits and code transmitters as per the GDO-8 instruction manual.
2. Press either the "OSC" buttons, or use a transmitter to operate the opener.

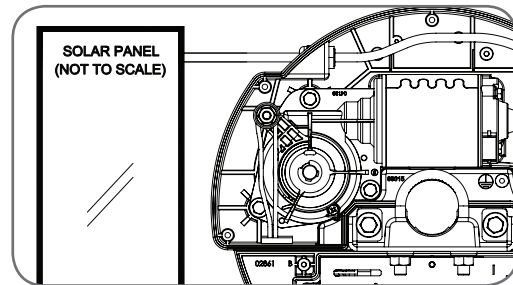

Fig 21

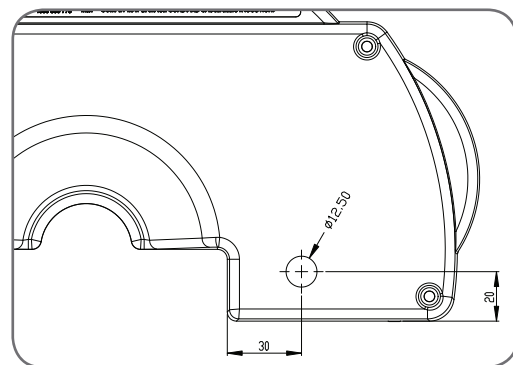

Fig 22

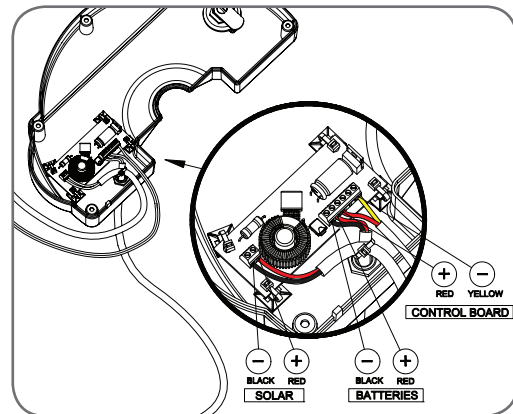

Fig 23

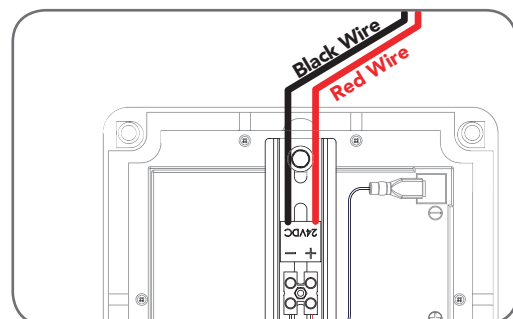

Fig 24





Specifications

SmartSolar™ Technical Specifications*	Garage Door	Slider	Swing Gate
Load Voltage	24	24	24
Load Continuous Current	3 - 5A	5A	5 - 10A
Number of Cycles per Day	10	10	10
Average Cycle Time (Opening and Closing)	40 seconds	90 seconds	72 seconds
Max. Standby Current - Without P.E. Beams	100mA	100mA	100mA
- With P.E. Beams	180mA	180mA	180mA
- With 2 x P.E. Beams			260mA
Average total consumption current per day - Without P.E. Beams	2.75 - 3Ah	3.7Ah	3.4 - 4.4Ah
- With P.E. Beams	4.66 - 4.8Ah	5.55Ah	5.31 - 6.3Ah
- With 2 x P.E. Beams			7.23 - 8.23Ah
Average total consumption current per hour - Without P.E. Beams	0.11 - 0.13A	0.16A	0.14 - 0.18A
- With P.E. Beams	0.194 - 0.2A	0.23A	0.22 - 0.26A
- With 2 x P.E. Beams			0.3 - 0.343A
Recommended storage battery capacity / voltage	10.5Ah/24v	12Ah/24V	12 - 18Ah/24V
Wire Gauge and Length from Battery to Charger board (max)	18AWG, 3m	18AWG, 3m	18AWG, 3m
Solar panel average rated output generation time per day (winter months)	4 hours	4 hours	4 hours
Solar Panel Output voltage / current	18V / 1.19A	18V / 1.75A	18V / 1.75A





Warranty and exclusion of liability

1. This warranty is an addition to any non-excludable conditions or warranties that are implied into this contract by relevant statute, including the Trade Practices Act 1974 (Cwth).
2. Subject to all of the matters set out below, Automatic Technology Australia Pty Ltd ("ATA") warrants: SmartSolar™ kit for twelve (12) months from the date of purchase (specified in the sales docket receipt) as free of any defects in material and workmanship.
3. This warranty applies only where the purchaser:
 - (a) immediately notifies ATA or the retailer of the alleged defect;
 - (b) returns the product to the retailer; and
 - (c) presents the relevant sales docket and this warranty document to the retailer to confirm the date of purchase.
4. Except for this warranty, ATA gives no warranties of any kind whatsoever (whether express or implied), in relation to the product, and all warranties of whatsoever kind relating to the product are, to the extent permissible by statute, hereby excluded.
5. To the extent permissible by statute, ATA disclaims any liability of whatsoever nature in respect of any claim or demand for loss or damage which arises out of:
 - a. accidental damage to or normal wear and tear to the product or to the product's components;
 - b. any cost relating to damage resulting from wear and tear;
 - c. loss or damage due to theft, fire, flood, rain, water, lightning, storms or any other acts of God;
 - d. maximum operating force exceeding 15kg (150N) when moving the door or gate manually to the open or closed position;
 - e. door surface area and/or weight exceeding 16.5m² and 100kg respectively;
 - f. residential gate weight exceeding 400kg;
 - g. door or gate not in safe and correct working order and condition;
 - h. evidence of unauthorised repairs;
 - i. any cost relating to damage caused by misuse, negligence or failure to maintain the equipment in a proper working order as per clauses (d) through (i);
 - j. installation, adjustment or use which is not in accordance with the instructions set out in installation instruction manual
 - k. attempted or complete modification or repairs to the product carried out by a person who is not authorised or has not been trained by ATA to carry out such modification or repairs;
 - l. faulty or unsuitable wiring of structure to which the product is fixed or connected;
 - m. damage caused by insects;
 - n. loss or damage to any property whatsoever or any loss or expense whatsoever resulting or arising there from or any consequential loss;
 - o. any cost or expense arising due to manufacturer recall of any product;
 - p. any cost or expense due to negligence of the approved service provider;
 - q. installation of a residential garage door or gate opener in a commercial or industrial situation or a non-single residential dwelling.
6. ATA's liability under this warranty is limited, at ATA's absolute option, to replacing or repairing the product which ATA, in its unfettered opinion, considers to be defective either in material and/or workmanship or to credit the dealer with the price at which the product was purchased by the dealer.
7. This warranty does not extend to cover labour for installation.
8. This warranty is limited to Return-to-Base (RTB) repair and does not cover labour for on-site attendance.
9. This warranty is void if the Product is not returned to the manufacturer in original or suitably secure packaging.
10. This warranty is only applicable for repairs to the product carried out within Australia.
11. This warranty does not cover consumable items including globes, batteries and fuses.
12. This warranty is not transferable.
13. Where the Product is retailed by any person other than ATA, except for the warranty set out above, such person has no authority from ATA to give any warranty or guarantee on ATA's behalf in addition to the warranty set out above.





© December 2008 Automatic Technology (Australia) Pty Ltd. All rights reserved. SecuraCode®, EasyRoller®, EasySlider®, SecuraLift®, SecureSwing™, SecureSwing S™, SmartSolar™, SmartPlanet™ and Elite™ are trademarks and registered trademarks of Automatic Technology (Australia) Pty Ltd. No part of this document may be reproduced without prior permission. In an ongoing commitment to product quality we reserve the right to change specification without notice. E&OE.

automatic
TECHNOLOGY

smart | simple | secure

an alesco company

Automatic Technology (Australia) Pty Ltd

ABN 11 007 125 368

6-8 Fiveways Boulevard
Keysborough, Victoria, 3173, Australia

P 1300 133 944

+61 2 9722 5666 (International Enquiries Only)

E sales@ata-aust.com.au

www.ata-aust.com.au